











Pneumatic rotary actuator

- Modular program for mounting of quarter turn valves such as ball valves and butterfly valves
- NAMUR and ISO 5211 interfaces
- Position feedback with Type 1061 possible (also for Ex applications)
- SideControl Positioner ready - Type 8791/8792/8793
- ATEX 2014/34/EU

Product variants described in the data sheet may differ from the product presentation and description.

Can be combined with

	Type 2654 2/2-way ball valve, 3-piece	▶
	Type 2651 2/2-way or 3/2-way ball valve, 2-piece	▶
	Type 2671 Butterfly valve	▶
	Type 2657 Ball valve, manually operated	▶
	Type 2674 Plastic butterfly valve	▶
	Type 1061 Position feedback unit for pneumatic rotary actuators	▶
	Type 8792 Digital electropneumatic positioner SideControl	▶
	Type 6519 Servo-assisted 3/2, 5/2 or 5/3-way solenoid valve for pneumatics	▶

Type description

The actuator series 2051 includes single and double acting pneumatic linear piston actuators with a universal mechanical interface in accordance with ISO 5211. The actuator stem is rotated through 90° by the pressure force of the pilot air or the force of the reset fields. The rotary movement can in turn be used to actuate corresponding proportional valves such as ball valves or butterfly valves. The rotary actuator can also be combined with the positioners from the 8791/8792/8793 series. The actuator can be equipped with the end position feedback boxes from the 1061 series for pure position monitoring.

Table of contents

1. General technical data	3
2. Approvals and conformities	3
2.1. General notes	3
2.2. Conformity	3
2.3. Standards	3
2.4. Explosion protection.....	3
3. Control functions	4
4. Materials	4
4.1. Bürkert resistApp	4
5. Dimensions	5
6. Performance specifications	6
6.1. Air consumption	6
7. Product operation	7
7.1. Functional overview	7
8. Ordering information	8
8.1. Bürkert eShop	8
8.2. Bürkert product filter	8
8.3. Ordering chart	8
Double-acting actuator.....	8
Single-acting actuator	9
8.4. Ordering chart accessories.....	9
Position feedback Type 1061.....	9
Positioner Type 8792	10
Positioner mounting kit Type 8792/8793	10
Solenoid valve Type 6519	10
Cable plug Type 2518, form A according to DIN EN 175301 - 803	10
Reducing sleeves.....	11

1. General technical data

Product properties	
Dimensions	Further information can be found in chapter "5. Dimensions" on page 5.
Material	
Actuator	Aluminium alloy
Seal	Special NBR, FKM (on request)
Piston	Aluminium
Performance data	
Rotation angle	90°. adjustable to -5°...15° and 75°...95°
Adjustable angle	20° per end position
Pilot pressure	Single-acting actuator: 3...8 bar Double-acting actuator: 2.5...8 bar
Medium data	
Control medium	Filtered oil-free or lubricated compressed dry air
Process/Port connection & communication	
Pilot air ports	Flange interface according to NAMUR VDE/VDI 3845
Feedback signal	According to NAMUR VDE/VDI 3845
Armature-side interface	According to ISO 5211
Approvals and conformities	
Explosion protection	Further information can be found in chapter "2.4. Explosion protection" on page 3.
Environment and installation	
Ambient temperature	-40 °C...+80 °C (FKM: -15 °C...+150 °C)

2. Approvals and conformities

2.1. General notes

- The approvals and conformities listed below must be stated when making enquiries. This is the only way to ensure that the product complies with all required specifications.
- Not all available variants can be supplied with the below mentioned approvals or conformities.

2.2. Conformity

In accordance with the Declaration of Conformity, the product is compliant with the EU Directives.

2.3. Standards

The applied standards which are used to demonstrate compliance with the EU Directives are listed in the EU-Type Examination Certificate and/or the EU Declaration of Conformity.

2.4. Explosion protection

Approval	Description
	Optional: Explosion protection ATEX: Ex II 2GD c T95°C

3. Control functions

Symbol	Description
	<p>Control function A (CF A) Pneumatically operated 2/2-way on/off valve Flow direction above seat Normally closed by spring force</p>
	<p>Control function B (CF B) Single-acting actuator for pneumatically operated 2/2-way on/off valve Normally ed by spring force</p>
	<p>Control function I (CF I) Pneumatically operated 2/2-way on/off valve on either side Bidirectional Switching position dependent on external control</p>

4. Materials

4.1. Bürkert resistApp

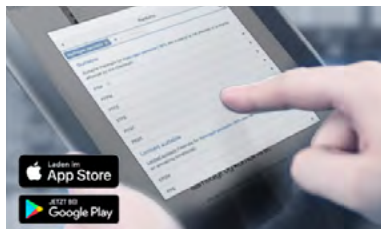

Bürkert resistApp – Chemical resistance chart

You want to ensure the reliability and durability of the materials in your individual application case? Verify your combination of media and materials on our website or in our resistApp.

[Start chemical resistance check](#)

5. Dimensions

Note:

Dimensions in mm, unless otherwise stated

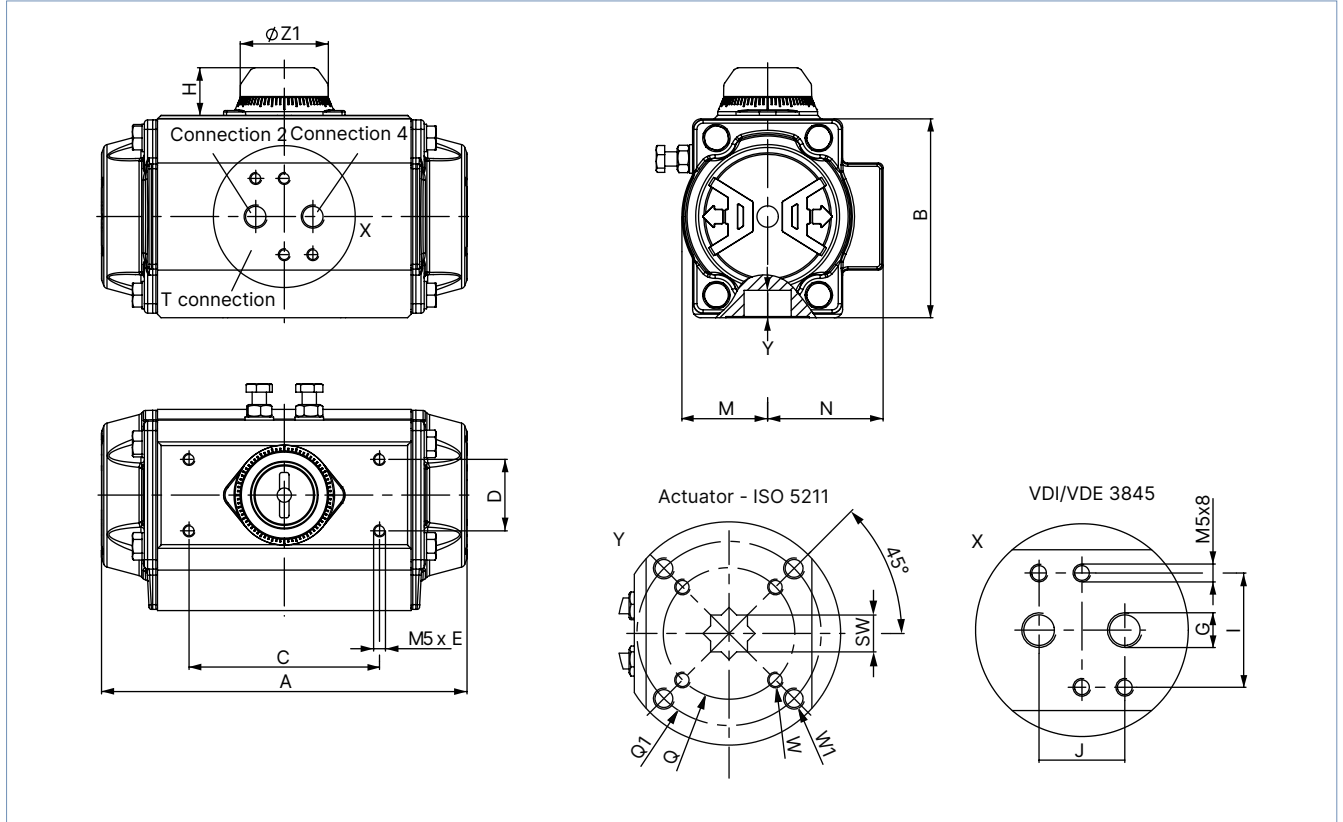

Size	A	B	C	D	E	H	I	J	M	N	Q	Q1	W	W1	ØZ1	G	Y ¹⁾	SW ²⁾	Interface acc. to ISO 5211 ²⁾
15	136	69	80	30	8	20	32	24	29	43	36	50	M5	M6	42	1/8"	12	11	F03/05
30	153.5	85	80	30	8	20	32	24	36	48.5	50	70	M6	M8	42	1/8"	16	14	F05/07
60	203.5	102	80	30	8	20	32	24	42.5	50.5	50	70	M6	M8	42	1/8"	18	14	F05/07
100	241	115	80	30	8	20	32	24	49.5	56.5	50	70	M6	M8	42	1/8"	19	17	F05/07
150	259	127	80	30	8	20	32	24	55.5	63	70	102	M8	M10	42	1/4"	24	17	F07/10
220	304	145	80	30	8	30	32	24	64	72	70	102	M8	M10	58	1/4"	30	22	F07/10
300	333	157	80	30	8	30	32	24	69.5	77	70	102	M8	M10	58	1/4"	34	22	F07/10
450	394.5	177	80	30	8	30	32	24	80	86	102	125	M10	M12	67.5	1/4"	39	27	F10/12
600	422.5	196	80	30	8	30	32	24	88	93	102	125	M10	M12	67.5	1/4"	40	27	F10/12
900	474	220.5	130	30	8	50	32	24	99	101	102	125	M16	-	80	1/4"	39	27	F10/12
1200	528	245	130	30	8	50	32	24	110	111.5	102	125	M16	-	80	1/4"	40	27	F10/12
2000	605	298.5	130	30	8	50	45	40	131	131	140	-	M20	-	115	3/8"	63	36	F14
3000	710	330	130	30	8	50	45	40	165	165	165	-	M20	-	115	1/2"	51	46	F16
4000	812	383	130	30	8	50	45	40	185.5	185.5	165	-	M20	-	115	1/2"	51	46	F16
5000	876	410	130	30	8	50	45	40	204	214	165	254	M20	M16	115	1/2"	60	55	F16/25
10000	950	518	200	50	M6 x 10	80	45	40	255	273	165	254	M20	M16	115	1/2"	80	75	F16/25/30

1.) The depth depends on the width across flats SW (other depths for different width across flats are possible).

2.) Other interfaces on request

6. Performance specifications

6.1. Air consumption

Air consumption of actuators with a 90° rotation angle per stroke cycle [l/stroke]											
Actuator		Pilot pressure [bar]									
		2.5	3	3.5	4	4.5	5	5.5	6	7	8
15	DA	0.84	0.96	1.08	1.2	1.32	1.44	1.56	1.68	1.92	2.16
	SA	0.32	0.36	0.41	0.45	0.50	0.54	0.59	0.63	0.72	0.81
30	DA	1.47	1.68	1.89	2.1	2.31	2.52	2.73	2.94	3.36	3.78
	SA	0.56	0.64	0.72	0.8	0.88	0.96	1.04	1.12	1.28	1.44
60	DA	2.8	3.2	3.6	4	4.4	4.8	5.2	5.6	6.4	7.2
	SA	1.09	1.24	1.40	1.55	1.71	1.86	2.02	2.17	2.48	2.79
100	DA	4.52	5.16	5.81	6.45	7.1	7.74	8.39	9.03	10.32	11.61
	SA	1.79	2.04	2.3	2.55	2.81	3.06	3.32	3.57	4.08	4.59
150	DA	6.37	7.28	8.19	9.1	10.01	10.92	11.83	12.74	14.56	16.38
	SA	2.49	2.84	3.2	3.55	3.91	4.26	4.62	4.97	5.68	6.39
220	DA	10.47	11.96	13.46	14.95	16.45	17.94	19.44	20.93	23.92	26.91
	SA	4.17	4.76	4.76	5.95	6.55	7.14	7.74	8.33	9.52	9.52
300	DA	13.58	15.52	17.46	19.40	21.34	23.28	25.22	27.16	31.04	34.92
	SA	5.39	6.16	6.93	7.70	8.47	9.24	10.01	10.78	12.32	13.86
450	DA	21.67	24.76	27.86	30.95	34.05	37.14	40.24	43.33	49.52	55.71
	SA	8.44	9.64	10.85	12.05	13.26	14.46	15.67	16.87	19.28	21.69
600	DA	28.21	32.24	36.27	40.30	44.33	48.36	52.39	56.42	64.48	72.54
	SA	10.99	12.56	14.13	15.7	17.27	18.84	20.41	21.98	25.12	28.26
900	DA	39.03	44.6	50.18	55.75	61.33	66.9	72.48	78.05	89.20	100.35
	SA	14.91	17.04	19.17	21.3	23.43	25.56	27.69	29.82	34.08	38.34
1200	DA	53.9	61.60	69.30	77	84.7	92.4	100.1	107.8	123.2	138.6
	SA	20.79	23.76	26.73	29.7	32.67	35.64	38.61	41.58	47.52	53.46
2000	DA	88.2	100.8	113.4	126	138.6	151.2	163.8	176.4	201.6	226.8
	SA	35	40	45	50	55	60	65	70	80	90
3000	DA	125.58	143.52	161.46	179.4	197.34	215.28	233.22	251.16	287.04	322.92
	SA	50.75	58	65.25	72.5	79.75	87	94.25	101.5	116	130.5
4000	DA	185.5	212	238.5	265	291.5	318	344.5	371	424	477
	SA	70	80	90	100	110	120	130	140	160	180
5000	DA	227.5	260	292.5	325	357.5	390	422.5	455	520	585
	SA	87.5	100	112.5	125	137.5	150	162.5	175	200	225
10000	DA	465.5	532	598.5	665	731.5	798	864.5	931	1064	1197
	SA	171.5	196	220.5	245	269.5	294	318.5	343	392	441

Calculation: $Q = n \cdot V \cdot (p_e + p_{amb}) / p_{amb}$, Q: air consumption, n: cycles, p_e : pilot pressure, p_{amb} : air pressure, V: actuator cylinder volume
 Definition of stroke cycle: DA → 1 x (0°...90°) and 1 x CLOSED (90°...0°)
 SA → 1 x (0°...90°) and 1 x CLOSED (90°...0°) by spring

DTS 1000104926 EN Version: Q Status: RL (released | freigegeben | validé) printed: 18.12.2024

7. Product operation

7.1. Functional overview

Note:

- Illustration shows top view
- Further information about the control functions can be found in chapter “3. Control functions” on page 4.

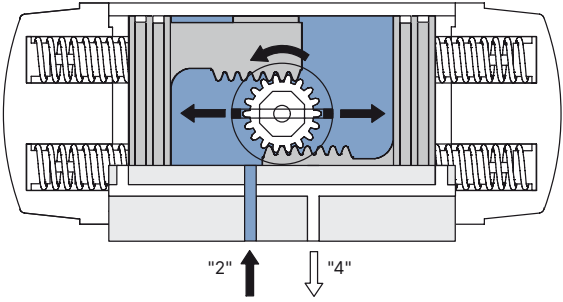
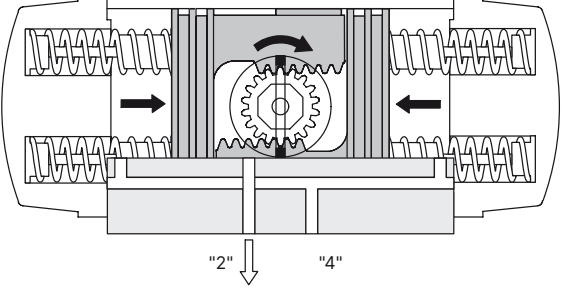
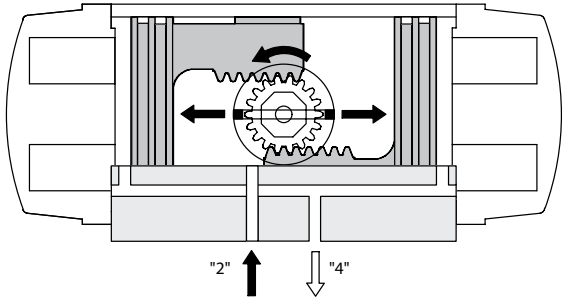
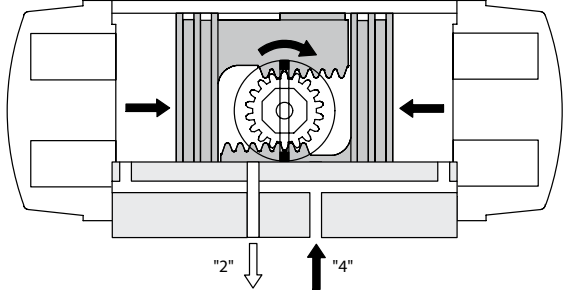
Control function A	Description
	<p>The air supplied to port 2 forces the pistons towards the actuator end caps, compressing the springs. This triggers a counter-clockwise rotation. The exhaust air exits from port 4.</p>
	<p>The loss of air pressure (ventilation or electric failure) at Port 2 allows the springs to force the pistons inward. This triggers a clockwise rotation. The exhaust air exits from port 2.</p>
Control function B	
<p>With control function B, the direction of rotation is opposite to control function A.</p>	
Control function I	Description
	<p>The air supplied to port 2 forces the pistons towards the actuator end caps. This triggers a counter-clockwise rotation. The exhaust air exits from port 4.</p>
	<p>The air supplied to port 4 forces the pistons inward. This triggers a clockwise rotation. The exhaust air exits from port 2.</p>

DTS 1000104926 EN Version: Q Status: RL (released | freigegeben | valide) printed: 18.12.2024

8. Ordering information

8.1. Bürkert eShop



Bürkert eShop – Easy ordering and quick delivery

You want to find your desired Bürkert product or spare part quickly and order directly? Our online shop is available for you 24/7. Sign up and enjoy all the benefits.

[Order online now](#)

8.2. Bürkert product filter

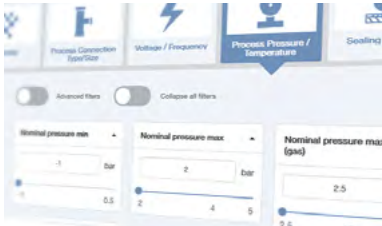

Bürkert product filter – Get quickly to the right product

You want to select products comfortably based on your technical requirements? Use the Bürkert product filter and find suitable articles for your application quickly and easily.

[Try out our product filter](#)

8.3. Ordering chart

Double-acting actuator

Note:

- Control function I (see: “3. Control functions” on page 4)
- Other variants on request

Actuator size	Torque (depending on the pilot pressure)							Air volume		Rotation time ¹⁾		Weight [kg]	Article no.
	3 bar [Nm]	4 bar [Nm]	5 bar [Nm]	5.5 bar [Nm]	6 bar [Nm]	7 bar [Nm]	8 bar [Nm]	Open [l]	Closed [l]	Open [s]	Closed [s]		
15	10	13.3	16.6	18.3	19.9	23.3	26.6	0.09	0.15	0.2	0.25	1	214520
30	17.6	23.5	29.3	32	35.2	41	46.9	0.16	0.26	0.25	0.3	1.6	214522
60	34.9	46.5	58.2	64	69.8	81.4	93.1	0.31	0.49	0.3	0.35	2.7	214524
100	54.9	73.2	91.5	101	110	128	146	0.51	0.78	0.4	0.5	3.7	214525
150	79.8	106	133	146	160	186	213	0.71	1.11	0.5	0.6	5.2	214526
220	129	172	215	236	258	301	344	1.19	1.8	0.7	0.8	8	214527
300	166	222	277	305	332	388	433	1.54	2.34	0.9	1.1	9.8	214528
450	261	348	435	478	522	609	696	2.41	3.78	1.2	1.4	14.2	220987
600	340	454	567	624	681	794	908	3.14	4.92	1.5	1.7	17.8	286926
900	459	613	766	842	919	1072	1225	4.26	6.89	2	2.2	24.3	286928
1200	638	851	1064	1170	1276	1489	1702	5.94	9.46	2.7	3.2	34.3	286931
2000	1072	1430	1787	1966	2144	2502	2859	10	15.2	3.5	4	54.6	286934
3000	1556	2075	2594	2853	3112	3631	4150	14.5	21.38	4	4.5	76.3	On request
4000	2154	2872	3590	3949	4308	5026	5744	20	33	5	6	118	On request
5000	2703	3604	4504	4955	5405	6306	7207	25	40	6	7	127	On request
10000	5003	6671	8339	9173	10007	11674	–	49	84	8	9	170	On request

1.) The operating times of the actuator were determined under the following test conditions: (1) room temperature, (2) angle of rotation 90°, (3) solenoid valve with Ø 11 mm and flow rate Qn 6000 l/min, (4) internal Ø 11 mm, (5) medium technical air, (6) air pressure 5.5 bar, (7) actuator without external load.
 Caution: closing times may change under different operating conditions. Control medium: the control medium must be free of dust and oil. The maximum particle size must not exceed 30 µm (ISO 8573 Part 1, Class 5). To avoid water condensation and/or ice formation (at working temperatures below 0 °C), the medium must have a dew point of -20 °C or at least 10 °C below ambient temperature (ISO 8573 Part 1, Class 3).

Single-acting actuator

Note:

- Control function A (see: “3. Control functions” on page 4)
- 6 spring packages per side

Actuator size	Torque (depending on the pilot pressure)						Spring force		Air volume		Rotation time ¹⁾		Weight [kg]	Article no. (Control function A)	Article no. (Control function B)
	5.5 bar		6 bar		8 bar		90°	0°	Open [l]	Closed [l]	Open [s]	Closed [s]			
	0°	90°	0°	90°	0°	90°									
	[Nm]	[Nm]	[Nm]	[Nm]	[Nm]	[Nm]									
15	10.2	6.6	11.9	8.2	18.5	14.9	11.7	8.1	0.09	0.15	0.25	0.3	1.1	214529	214537
30	18.9	12	21.9	14.9	33.6	26.7	20.2	13.3	0.16	0.26	0.3	0.35	1.7	214530	214538
60	37.5	22.4	43.3	28.3	66.5	51.5	41.5	26.5	0.31	0.49	0.4	0.5	3.1	214531	214539
100	56.7	31.4	65.8	40.5	102	77.1	69.3	44	0.51	0.78	0.5	0.6	4.3	214532	214540
150	85.4	51.7	99	65	152	118	94.5	60.8	0.71	1.11	0.7	0.9	6.1	214533	214541
220	138	79	159	101	245	187	157	98.4	1.19	1.8	0.9	1.1	9.3	214534	214542
300	179	107	206	135	317	245	198	126	1.54	2.34	1.2	1.4	12	214535	214543
450	281	169	324	213	498	386	309	198	2.41	3.78	1.5	1.8	17	214536	214545
600	355	255	411	282	638	509	399	269	3.14	4.92	1.8	2.1	21.4	286924	286925
900	463	274	540	351	846	657	568	379	4.26	6.89	2.4	2.8	32.7	284700	286927
1200	660	414	766	520	1192	946	756	510	5.94	9.46	3.5	4	43.6	286929	286930
2000	1101	715	1279	894	1994	1608	1251	865	10	15.2	4.1	4.6	69	286932	286933
3000	1544	931	1803	1190	2840	2228	1922	1309	14.5	21.38	4.5	5	95.5	On request	On request
4000	2194	1329	2553	1688	3989	3124	2620	1754	20	33	6	7	150	On request	On request
5000	2748	1983	3198	2434	5000	4236	2971	2207	25	40	7.5	8.5	168.5	On request	On request
10000	5105	3233	5938	4067	9274	7403	5939	4068	49	84	10	11	238	On request	On request

1.) The operating times of the actuator were determined under the following test conditions: (1) room temperature, (2) angle of rotation 90°, (3) solenoid valve with Ø 11 mm and flow rate Qn 6000 l/min, (4) internal Ø 11 mm, (5) medium technical air, (6) air pressure 5.5 bar, (7) actuator without external load.
 Caution: closing times may change under different operating conditions. Control medium: the control medium must be free of dust and oil. The maximum particle size must not exceed 30 µm (ISO 8573 Part 1, Class 5). To avoid water condensation and/or ice formation (at working temperatures below 0 °C), the medium must have a dew point of - 20 °C or at least 10 °C below ambient temperature (ISO 8573 Part 1, Class 3).

8.4. Ordering chart accessories

Position feedback Type 1061

Note:

- Adjustable mounting bracket included
- Further variants see data sheet **Type 1061** ▶

Description	Article no.
Position feedback indicator (electromechanical) (Type 1061)	773151
Position feedback indicator (electromechanical) with integrated 3/2-way solenoid valve (Type 1061)	773139
Position feedback indicator (electromechanical) with integrated 5/2-way solenoid valve (Type 1061)	773140
Position feedback indicator (inductive) (Type 1061)	773152
Position feedback indicator (inductive) with integrated 3/2-way solenoid valve (Type 1061)	773141
Position feedback indicator (inductive) with integrated 5/2-way solenoid valve (Type 1061)	773142
Position feedback indicator (inductive) (Type 1061), ATEX variant	773153
Position feedback indicator (inductive) with integrated 3/2-way solenoid valve (Type 1061), ATEX variant	773143
Position feedback indicator (inductive) with integrated 5/2-way solenoid valve (Type 1061), ATEX variant	773144

DTS 1000104926 EN Version: Q Status: RL (released | freigegeben | validé) printed: 18.12.2024

Positioner Type 8792

Note:

Further variants see data sheet [Type 8792](#) ▶.

Description	Article no.
NAMUR SideControl positioner without analogue feedback (Type 8792)	317985
NAMUR SideControl positioner with analogue feedback (Type 8792)	317986

Positioner mounting kit Type 8792/8793

Note:

Further variants see data sheet [Type 8792](#) ▶ or [Type 8793](#) ▶.

Description	Article no.
Attachment kit for stainless steel rotary actuators according to VDI/VDE 3845 (IEC 60534 - 6 - 2)	787338
Stainless steel universal assembly bridge according to VDI/VDE 3845 (IEC60534 - 6 - 2)	770294

Solenoid valve Type 6519

Note:

Further variants see data sheet [Type 6519](#) ▶.

Description	Article no.
3/2 and 5/2-way pneumatic valve, 32 mm, 24 V AC, NAMUR (Type 6519)	131421
3/2 and 5/2-way pneumatic valve, 32 mm, 110 V AC, NAMUR (Type 6519)	131423
3/2 and 5/2-way pneumatic valve, 32 mm, 230 V AC, NAMUR (Type 6519)	131424

Cable plug Type 2518, form A according to DIN EN 175301 - 803











Note:

Further variants see data sheet [Type 2518](#) ▶.

Cable plug	Dimensions	Variant	Voltage	Article no.
		Without circuitry (AC/DC)	0...250 V AC/DC	314802

DTS 1000104926 EN Version: Q Status: RL (released | freigegeben | validé) printed: 18.12.2024

Reducing sleeves

Description	Article no.
Reducing sleeve double square/square 14/9 mm	665288 
Reducing sleeve double square/square 14/11 mm	665289 
Reducing sleeve square/square 17/14 mm	665290 
Reducing sleeve double square/square 17/14 mm	773348 
Reducing sleeve double square/square 17/11 mm	773343 
Reducing sleeve square/square 22/19 mm	773836 
Reducing sleeve double square/square 22/17 mm	684858 
Reducing sleeve double square/double square 22/14 mm	666684 
Reducing sleeve double square/square 22/11 mm	773344 
Reducing sleeve double square/square 27/22 mm	774594 
Reducing sleeve square/square 27/19 mm	774279 
Reducing sleeve square/square 27/17 mm	774193 