

2/2-Way, Direct-acting, G1/8 - M5



Advantages/Benefits

- ▶ Compact design
- ▶ Specific testing and cleaning available
- ▶ Short response time
- ▶ Electrical connection: DIN-plug or leads
- ▶ Body materials: brass, stainless steel

Design/Function

Type 200 is a direct-acting plunger-type solenoid valve normally closed by spring action (circuit function A).

When energized, the solenoid armature is drawn against a spring to open the valve.

The solenoid epoxy encapsulation efficiently dissipates the heat generated by the coil.

Specific testing and cleaning is available according to application requirements.

Applications

- Laboratory instruments
- Small-scale instrument
- Gas control instruments
- Shut-off, dosing, filling, ventilating
- Welding technology
- Neutral gases and liquids
- Slightly aggressive liquids
- Pneumatic control
- Vacuum

burkert
Easy Fluid Control Systems

Technical Data

Circuit Function

A 2/2-way valve,
normally closed

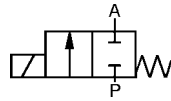

Operating Data (Valve)

Pressure range max.	0-21 bar (see specifications)
Port connection	Threaded port G 1/8", M5 Subbase on request.
Orifice	DN 1.2 - 2.4 mm >DN 2.4 mm on request.
Fluid	Neutral gases and liquids, e.g. compressed air, town gas, natural gas, water, hydraulic oil, petrol. Stainless steel version: Slightly aggressive media. Suitable for techn. vacuum.
Medium temperature max.	-10 to +100 °C
Max. ambient temperature	+55 °C
Max. viscosity	21 mm ² /s
Response times	
opening	5-18 ms
closing	ca. 8 ms
Installation	as required, but preferably with solenoid system upright

Operating Data (Actuator)

Operating voltages	AC 24, 110, 230 V/50 Hz, DC 12, 24 V/=						
Voltage tolerance	±10 %						
Power consumption	<table border="1"> <thead> <tr> <th>AC inrush</th> <th>AC hold</th> <th>DC</th> </tr> </thead> <tbody> <tr> <td>9 VA</td> <td>6 VA/4 W</td> <td>4 W¹⁾</td> </tr> </tbody> </table>	AC inrush	AC hold	DC	9 VA	6 VA/4 W	4 W ¹⁾
AC inrush	AC hold	DC					
9 VA	6 VA/4 W	4 W ¹⁾					
	¹⁾ Power consumption DC 2 W on request						
Duty cycle Duty cycle for multiple manifolds	100% continuously rated 60% for manifold mounting (30 min) or use 2W-version (on request)						
Cycling rate	up to 1 000 c.p.m.						
Protection class with cable plug	IP 65						
Electr. connection	Delivery standard: Cable plug DIN 43 650 B, 0-250 V. Flying leads 300 mm length						

Materials

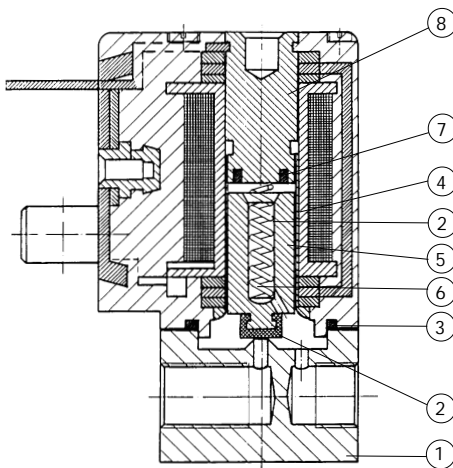

1 Valve body:	Brass, Stainless steel
2 Plunger-seal:	FKM, EPDM
3 O-rings:	FKM, EPDM
4 Armature guide tube:	S.Steel 1.4303
5 Plunger:	S.Steel 1.4105
6 Spring:	S.Steel 1.4310
7 Shading ring:	Cu (brass version)
8 Stopper:	1.4105

Specifications - Ordering Chart (Other Versions on Request)



Brass valve body, cable plug DIN 43 650 form B

Port connection	Orifice [mm]	Kv-Value (water) [m³/h]	Pressure Range		Seal material	Weight [kg]	ITEM - No.			
			(AC) [bar]	(DC) [bar]			Voltage / Frequency [V/Hz]			
			12/DC	24/DC			110/50	230/50		
G 1/8	1.2	0.045	0-21	0-12	FKM	0.12	053 702 A	054 121 L	---	---
G 1/8	1.2	0.045	0-21	0-12	EPDM	0.12	136 382 R	040 598 H	---	---
G 1/8	1.6	0.06	0-12	0- 6	FKM	0.10	041 635 S	056 694 V	136 378 C	136 379 D
G 1/8	1.6	0.06	0-12	0- 6	EPDM	0.10	136 385 L	022 917 A	136 395 N	136 396 P
G 1/8	2.0	0.11	0- 8	0- 4.5	FKM	0.12	045 781 Z	136 374 Y	136 380 T	136 381 Q
G 1/8	2.0	0.11	0- 8	0- 4.5	EPDM	0.12	136 388 X	136 390 V	136 397 Q	136 398 Z
G 1/8	2.4	0.13	0- 6	0- 3	FKM	0.09	056 256 D	050 223 A	---	---
G 1/8	2.4	0.13	0- 6	0- 3	EPDM	0.09	136 392 K	046 074 Y	---	---

Brass valve body, coil with two flying leads, 300 mm length

Port connection	Orifice [mm]	Kv-Value (water) [m³/h]	Pressure Range		Seal material	Weight [kg]	ITEM - No.			
			(AC) [bar]	(DC) [bar]			Voltage / Frequency [V/Hz]			
			12/DC	24/DC			110/50	230/50		
G 1/8	1.2	0.045	0-21	0-12	FKM	0.12	136 369 B	136 370 G	---	---
G 1/8	1.2	0.045	0-21	0-12	EPDM	0.12	136 383 J	136 384 K	---	---
G 1/8	1.6	0.06	0-12	0- 6	FKM	0.10	136 371 V	136 372 W	---	---
G 1/8	1.6	0.06	0-12	0- 6	EPDM	0.10	136 386 M	136 387 N	---	---
G 1/8	2.0	0.11	0- 8	0- 4.5	FKM	0.12	136 373 X	136 375 Z	---	---
G 1/8	2.0	0.11	0- 8	0- 4.5	EPDM	0.12	136 389 Y	136 391 J	---	---
G 1/8	2.4	0.13	0- 6	0- 3	FKM	0.09	136 376 S	136 377 T	---	---
G 1/8	2.4	0.13	0- 6	0- 3	EPDM	0.09	136 393 L	136 394 M	---	---

Stainless steel valve body, cable plug DIN 43 650 form B

Port connection	Orifice [mm]	Kv-Value (water) [m³/h]	Pressure Range		Seal material	Weight [kg]	ITEM - No.			
			(AC) [bar]	(DC) [bar]			Voltage / Frequency [V/Hz]			
			12/DC	24/DC			110/50	230/50		
G 1/8	1.2	0.045	0-21	0-12	FKM	0.12	023 294 K	050 035 Z	---	---
M5	1.2	0.045	0-21	0-12	EPDM	0.12	136 430 M	136 432 B	---	---
G 1/8	1.6	0.06	0-12	0- 6	FKM	0.10	049 026 T	042 050 G	066 462 W	136 407 K
M5	1.6	0.06	0-12	0- 6	EPDM	0.10	136 434 D	121 804 J	---	---
G 1/8	2.0	0.11	0- 8	0- 4.5	FKM	0.12	048 025 Z	054 290 A	136 408 U	136 409 V
M5	2.0	0.11	0- 8	0- 4.5	EPDM	0.12	136 437 G	136 439 J	---	---
G 1/8	2.4	0.13	0- 6	0- 3	FKM	0.09	124 283 J	040 670 U	---	---
M5	2.4	0.13	0- 6	0- 3	EPDM	0.09	136 441 L	136 443 N	---	---

Stainless steel valve body, coil with two flying leads, 300 mm length

Port connection	Orifice [mm]	Kv-Value (water) [m³/h]	Pressure Range		Seal material	Weight [kg]	ITEM - No.			
			(AC) [bar]	(DC) [bar]			Voltage / Frequency [V/Hz]			
			12/DC	24/DC			110/50	230/50		
G 1/8	1.2	0.045	0-21	0-12	FKM	0.12	136 399 S	136 400 Y	---	---
M5	1.2	0.045	0-21	0-12	EPDM	0.12	136 431 A	136 433 C	---	---
G 1/8	1.6	0.06	0-12	0- 6	FKM	0.10	136 401 M	136 402 N	---	---
M5	1.6	0.06	0-12	0- 6	EPDM	0.10	136 435 E	136 436 F	---	---
G 1/8	2.0	0.11	0- 8	0- 4.5	FKM	0.12	136 403 P	136 404 Q	---	---
M5	2.0	0.11	0- 8	0- 4.5	EPDM	0.12	136 438 R	136 440 X	---	---
G 1/8	2.4	0.13	0- 6	0- 3	FKM	0.09	136 405 R	136 406 J	---	---
M5	2.4	0.13	0- 6	0- 3	EPDM	0.09	136 442 M	136 444 P	---	---

Options

- 2W versions
- 12V versions
- Specific testing and cleaning
- Sub-base versions for manifold

Dimensions Solenoid Valve [mm]

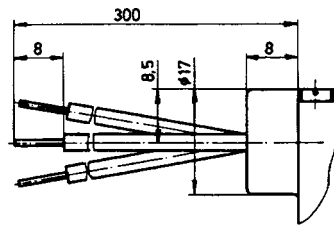
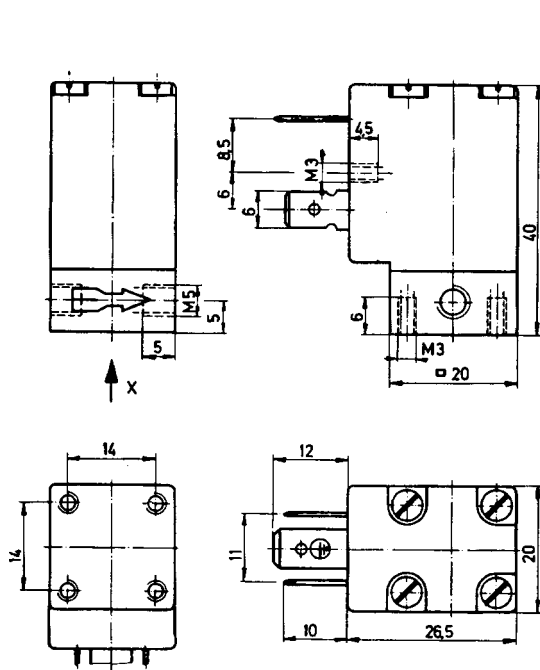

Please note for G 1/8 port connection:

Body length 25 mm, overall height 48 mm, M5 connection is retained at R port

Technical Data Cable Plug

Body material	PA (polyamide)
Contact material	brass, tinned
Cable outlet	vertically to the plug bottom
Isolation between cable plug and coil	gasket (NBR)
Temperature range	-30°C ... +90°C
Cable diameter	4.5 ... 7 mm
Electr. connection	terminal screws max. 1,5 mm ²
Poles	2pole + protective earth
Nominal voltage	0-250 V (Standard)
Isolation group	3
Rating	IP 65
Max. continuous current	16 A without wiring
Contact resistance	≤ 4 mΩ
Options	LED display Rectifier Varistor

Dimensions Cable Plug [mm]

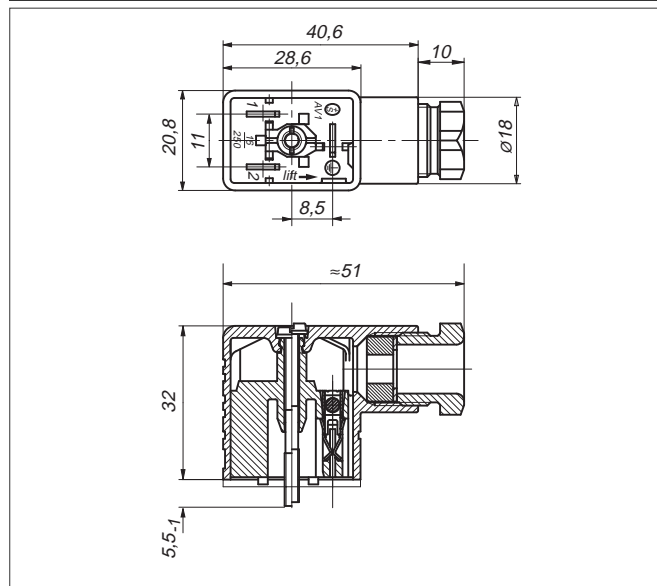

Wiring Diagrams/Connection Specifications

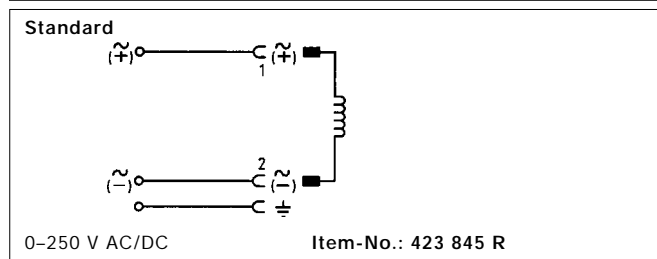

DTS 1000010913 EN Version: B Status: RL (released | freigegeben | validé) printed: 18.12.2024