



## 2/2 way compact flange ball valve

- Manually operated
- Low torques
- Long lifespan
- Maintenance friendly
- High flow rate



Product variants described in the data sheet may differ from the product presentation and description.

### Type description

2/2 way compact flange ball valve in stainless steel used to shut off medium flows.

DN15 -DN150

## Table of contents

<b>1. General technical data</b>	<b>3</b>
<b>2. Materials</b>	<b>3</b>
2.1. Chemical Resistance Chart – Bürkert resistApp.....	3
2.2. Material specifications .....	4
<b>3. Dimensions</b>	<b>5</b>
<b>4. Performance specifications</b>	<b>6</b>
4.1. Torques .....	6
4.2. Pressure temperature diagram.....	6
4.3. $K_{vs}$ values.....	6
<b>5. Ordering information</b>	<b>7</b>
5.1. Bürkert eShop – Easy ordering and quick delivery.....	7
5.2. Bürkert product filter.....	7
5.3. Ordering chart .....	7

## 1. General technical data

Product properties	
Dimensions	Detailed information can be found in chapter "3. Dimensions" on page 5.
Material	
Housing	Steel 1.0619 Stainless steel 1.4408
Ball	Stainless steel 1.4401
Seal	PTFE
Performance data	
Temperature range	Detailed information can be found in chapter "4.2. Pressure temperature diagram" on page 6
Version: Steel DIN/ISO 5211	- 10 °C to +200 °C
Version: Stainless steel DIN/ISO 5211	- 10 °C to +200 °C
Pressure range	Technical vacuum (10...3 Torr)...40 bar <sup>1.)</sup> PN40: DN 15...50 mm PN16: DN 65...150 mm Other pressure ranges on request
Product connections	
Orifice	Manually operated steel DIN/ISO 5211 DN15...150 Manually operated stainless steel DIN/ISO 5211 DN15...150

1.) Pressure values: Measured as overpressure to the atmospheric pressure

## 2. Materials

### 2.1. Chemical Resistance Chart – Bürkert resistApp

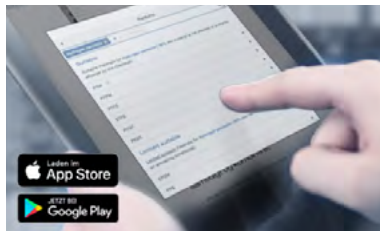

#### Bürkert resistApp – Chemical Resistance Chart

You want to ensure the reliability and durability of the materials in your individual application case? Verify your combination of media and materials on our website or in our resistApp.

[Start Chemical Resistance Check](#)

## 2.2. Material specifications

**Note:**

Integrated DIN/ISO 5211-Flange configuration

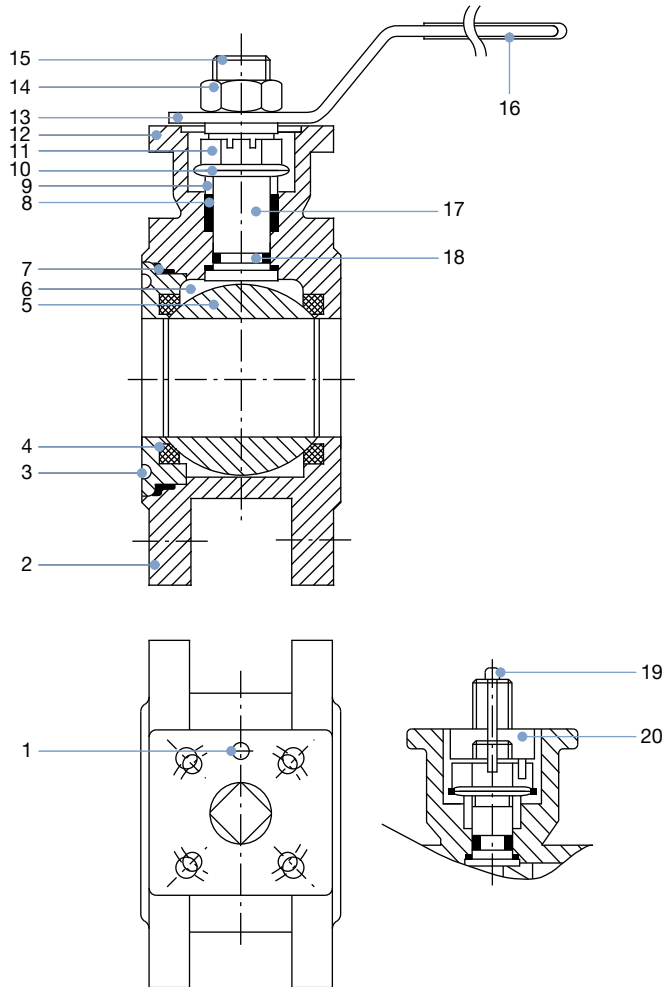

No.	Element	Qty	Material steel	Material stainless steel
1	Stopper	1	1.4301	1.4301
2	Body	1	1.0619	1.4408
3	Screw-in fitting	1	1.0619	1.4408
4	Ball seal	2	PTFE	PTFE
5	Ball	1	1.4301	1.4401
6	Pressure ring	1	PTFE	PTFE
7	Body seal	1	PTFE	PTFE
8	Ball stem seal	1 unit	PTFE	PTFE
9	Packing gland ring	2	1.4301	1.4301
10	Spring cup	2	SUS 301	SUS 301
11	Packing gland	1	1.4301	1.4301
12	Safety ring	1	1.4301	1.4301
13	Handle	1	1.4301	1.4301
14	Locknut	1	1.4301	1.4301
15	Gearshift lever shaft	1	1.4301	1.4401
16	Handle cover	1	Plastic	Plastic
17	Anti-static (optional)	1	1.4301	1.4301
18	O-ring	1	FKM	FKM
19	Spigot	1	1.4301	1.4301
20	Driver	1	1.4301	1.4301

### 3. Dimensions

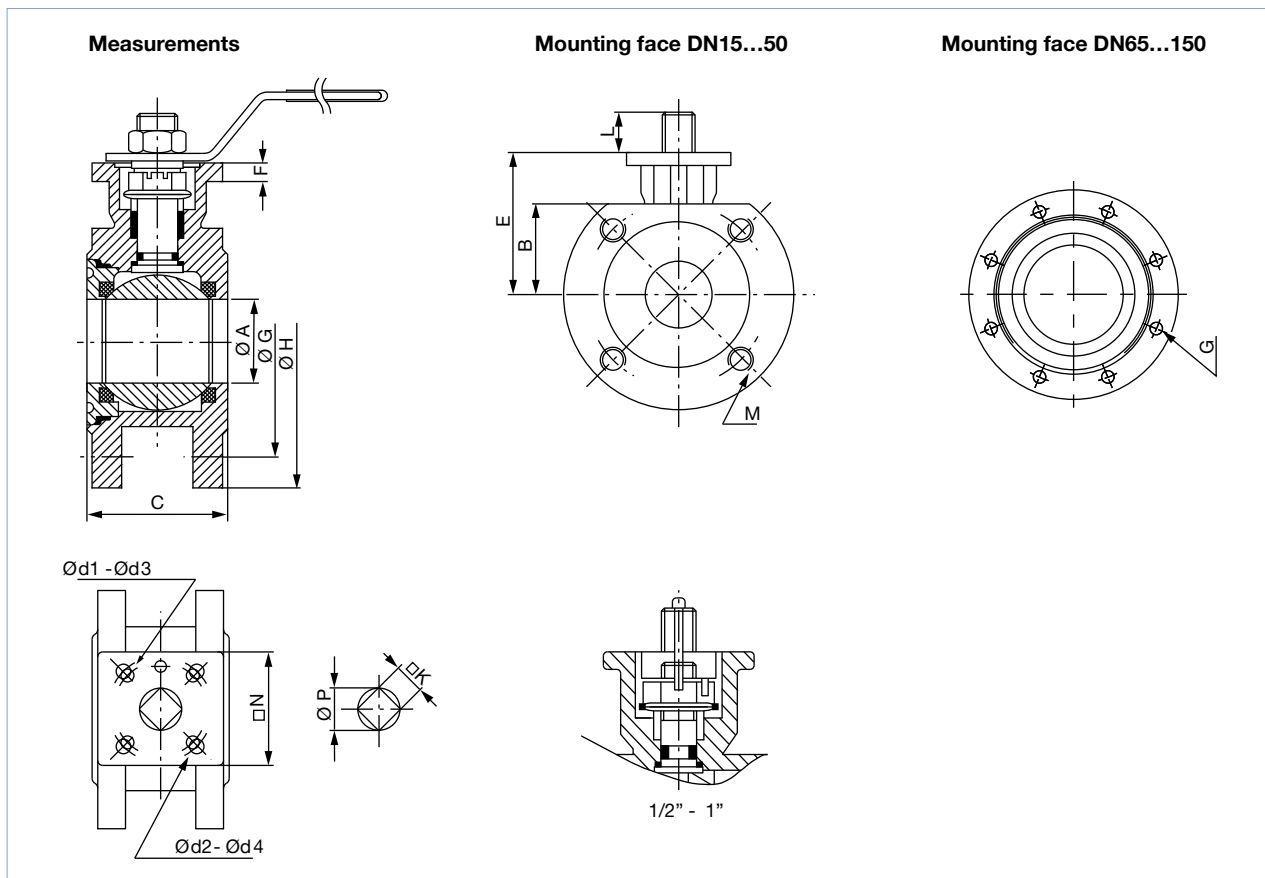

DN	C	Ø G	Ø H	Ø A	B	E	ISO 5211	Ø d1	Ø d2	Ø d3	Ø d4	K	L	M
[mm]	[mm]	[mm]	[mm]	[mm]	[mm]	[mm]		[mm]	[mm]	[mm]	[mm]	[mm]	[mm]	[mm]
15	40	65	95	15	34,5	60,0	F03/F04	36	42	6,0	5,5	9	8	M12×1,75
20	44	75	105	20	38,5	64,3	F03/F04	36	42	6,0	5,5	9	11	M12×1,75
25	53	85	115	25	44,6	64,6	F04/F05	42	50	5,5	7,0	11	11	M12×1,75
32	58,4	100	135	32	51	69,0	F04/F05	42	50	5,5	7,0	11	11	M16×2
40	62	110	145	38	55	76,3	F05/F07	50	70	7,0	8,5	14	17	M16×2
50	78	125	155	50	63	85,7	F05/F07	50	70	7,0	8,5	14	15	M16×2
65	100	145	185	65	73,5	105	F07	–	70	–	9,0	17	17	M16×2 (8 holes)
80	120	160	200	76	94	123	F07	–	70	–	9,0	17	17	M16×2 (8 holes)
100	152	180	220	96	105	132	F07/F10	70	102	9,0	10,5	17	29	M16×2 (8 holes)
125	180	188	250	114	125	157,5	F10/F12	102	125	10,5	12,5	27	36	M16×2 (8 holes)
150	215	212	285	135	142,5	172,5	F10/F12	102	125	10,5	12,5	27	36	M20×2,5 (8 holes)

DTS 1000112284 EN Version: K Status: RL (released | freigegeben | valide) printed: 07.09.2020

## 4. Performance specifications

### 4.1. Torques

DN [mm]	Breakaway torque [Nm]	Running torque [Nm]
15	10	7
20	13	9
25	17	11
32	24	16
40	35	23
50	54	36
65	85	60
80	117	82
100	148	98
125	265	195
150	355	250

### 4.2. Pressure temperature diagram

For general industrial use

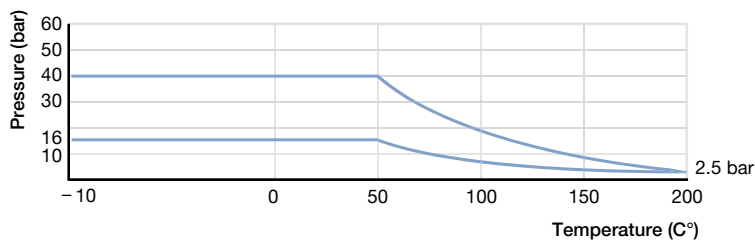

### 4.3. $K_{vs}$ values

Note:

- Nominal flow-rate value for water acc. to VDI/VDE 2173
- Measured at a medium temperature from + 15 °C, 1 bar<sup>1.)</sup> pressure at inlet and free outlet

DN [mm]	$K_{vs}$ value water [m <sup>3</sup> /h]
15	35
20	46
25	72
32	105
40	170
50	275
65	507
80	905
100	1414
125	2362
150	3674

1.) Pressure values: Measured as overpressure to the atmospheric pressure

## 5. Ordering information

### 5.1. Bürkert eShop – Easy ordering and quick delivery



#### Bürkert eShop – Easy ordering and fast delivery

You want to find your desired Bürkert product or spare part quickly and order directly? Our online shop is available for you 24/7. Sign up and enjoy all the benefits.

[Order online now](#)

### 5.2. Bürkert product filter



#### Bürkert product filter – Get quickly to the right product























You want to select products comfortably based on your technical requirements? Use the Bürkert product filter and find suitable articles for your application quickly and easily.

[Try out our product filter](#)

### 5.3. Ordering chart

#### Note:

Details about the dimensions see “[3. Dimensions](#)” on page 5.

DN [mm]	Article no. steel version	Article no. stainless steel version
15	788860 	784971 
20	788861 	787066 
25	788862 	784775 
32	788863 	784776 
40	788864 	784777 
50	788865 	784778 
65	788866 	784779 
80	788867 	784780 
100	788868 	784781 
125	788869 	784968 
150	788870 	784969 

# Bürkert – Close to You

For up-to-date addresses  
please visit us at  
[www.burkert.com](http://www.burkert.com)

DTS 1000112284 EN Version: K Status: RL (released | freigegeben | validé) printed: 07.09.2020

