







## Liquid Flow Meter (LFM)

- High dynamic flow measurement
- Applicable for liquid flow measurement up to 600 ml/min (36 l/h)
- No moving parts in medium
- Protection class IP65
- Fieldbus optional



Product variants described in the data sheet may differ from the product presentation and description.

### Can be combined with

	<b>Type 6011</b> Plunger valve 2/2 way direct-acting	▶
	<b>Type 8611</b> eCONTROL - Universal controller	▶
	<b>Type 6606</b> 2/2 or 3/2 way Rocker-Solenoid Valve with separating diaphragm	▶
	<b>Type 8619</b> multiCELL - Multi-channel and multi-function transmitter/controller	▶

### Type description

Type 8709 is an instrument for liquid flow measurement in process technology. The actual value supplied by the sensor is transmitted through the digital electronics and over a standard signal output or a field bus interface. In the device two calibration curves can be stored, which the user is able to switch between.

## Table of contents

<b>1. General technical data</b>	<b>3</b>
<b>2. Materials</b>	<b>4</b>
2.1. Chemical Resistance Chart – Bürkert resistApp.....	4
<b>3. Dimensions</b>	<b>5</b>
3.1. Standard version.....	5
<b>4. Device/Process connections</b>	<b>6</b>
4.1. Analogue version/Fieldbus version.....	6
<b>5. Product operation</b>	<b>7</b>
5.1. Measuring principle .....	7
<b>6. Ordering information</b>	<b>8</b>
6.1. Bürkert eShop – Easy ordering and quick delivery.....	8
6.2. Recommendation regarding product selection .....	8
6.3. Bürkert product filter.....	8
6.4. Ordering chart accessories.....	9
6.5. Adapter sketch.....	10

## 1. General technical data

Product properties	
<b>Material</b>	
Body	Stainless steel
Housing	PBT
Seal	FKM, EPDM or FFKM
Dimensions	115 × 137.5 × 37 (BxHxT) Detailed information can be found in chapter "3. Dimensions" on page 5.
Total weight	Approx. 1100 g
LED display	Indication for: 1. Power 2. Communication 3. Limit 4. Error
Performance data	
Full scale range ( $Q_{Nom}$ )	1.5...36l/h (25...600ml/min) regarding water
Measuring range	1:10
Max. operating pressure	Up to max. 10 barg; typical max. 2 barg
Measuring accuracy	± 1.5 % o. R. ± 0.5 % F. S.
Repeatability	± 0.5 % F. S.
Response time (t95 %)	< 500 ms
Electrical data	
Operating voltage	24 V DC
Power consumption	Max. 2.5 W (5 W with fieldbus version)
Voltage tolerance	± 10 %
Residual ripple	< 2 %
Electrical connection	Socket, round, 8 pin Socket, Sub-HD, 15 pin Plug or socket, M12 5 pin (with fieldbus version)
Medium data	
Operating medium	Clean and low viscous liquids
Calibration medium	Water (conversion to operating medium with correction function)
Medium temperature	- 10 °C...+ 40 °C
Viscosity (max.)	0.4 to 4 cSt
Process/Port connection & communication	
Port connection	G 1/8, NPT 1/8, G 1/4, NPT 1/4
Digital outputs	Two relay-output for: 1. Limit (process value close to $Q_{Nom}$ ) 2. Error (e. g. Sensor break) Current output: max. 60 V, 1 A, 60 VA
Digital inputs	Three switching inputs: 1. Not assigned 2. Not assigned 3. Not assigned
Digital (communication) interface	Digital via Fieldbus: • PROFIBUS DP V1 • CANopen
Analogue interfaces	4...20 mA, 0...20 mA, 0...10 V or 0...5 V Input impedance > 20 kΩ (Voltage) resp. < 300 Ω (Current) Max. load: 10 mA (Voltage output); Max. Load: 600 Ω (Current output)
Environment and installation	
Ambient temperature	0 °C...55 °C
Installation position	Horizontal or vertical
Degree of protection	IP65

## 2. Materials

### 2.1. Chemical Resistance Chart – Bürkert resistApp



#### **Bürkert resistApp – Chemical Resistance Chart**

You want to ensure the reliability and durability of the materials in your individual application case? Verify your combination of media and materials on our website or in our resistApp.

[Start Chemical Resistance Check](#)

### 3. Dimensions

#### 3.1. Standard version

**Note:**

- Dimensions in mm
- In devices without fieldbus communication there is no electrical M12 connector in the upper housing part.

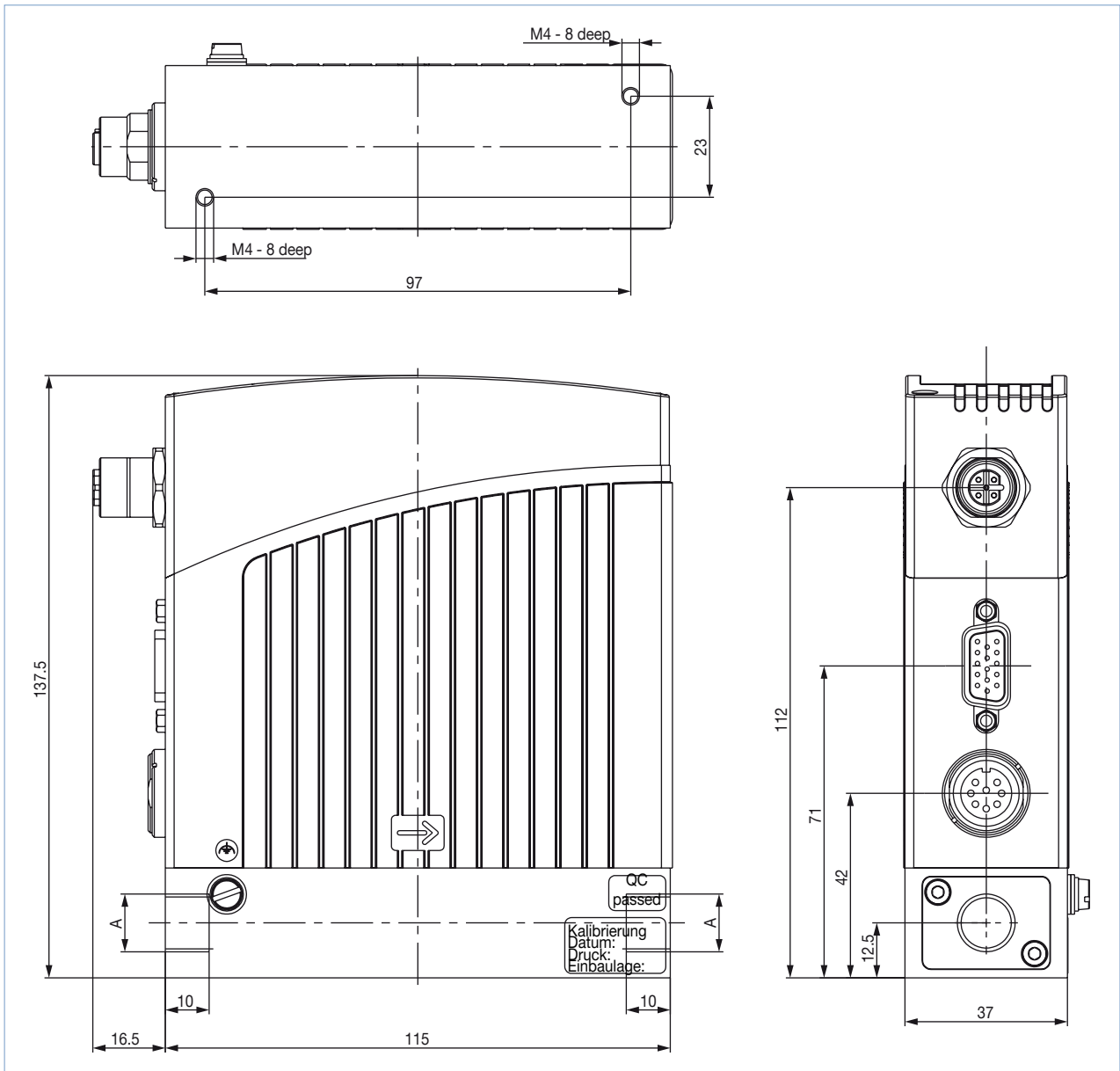

Size A	
G 1/8	G 1/4
NPT 1/8	NPT 1/4

DTS 1000116945 EN Version: J Status: RL (released | freigegeben | validé) printed: 14.03.2022

## 4. Device/Process connections

### 4.1. Analogue version/Fieldbus version

**Note:**

- Optional Pin 7 and 8 with bus version as transmitter input possible.
- The cable length for RS232/actual value signal is limited to 30 meters.

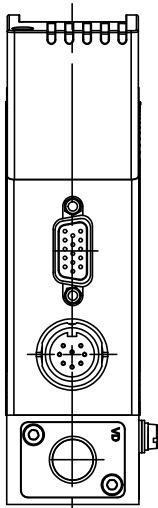

**Analogue version**

Socket D-Sub HD15	Pin	Assignment	
		Analogue control unit	Bus actuation
	1	Not connected	Not connected
	2	Not connected	Not connected
	3	Actual value output +	Not connected
	4	Binary input 2	
	5	12 V-Output (only for internal company use)	
	6	RS232 TxD (direct connection to computer)	
	7	Binary input 1	
	8	GND (for binary inputs)	
	9	only company internal use (do not connect!)	
	10	12 V-Output (only for internal company use)	
	11	12 V-Output (only for internal company use)	
	12	Binary input 3	
	13	Actual value output GND	Not connected
	14	RS232 RxD (direct connection to computer)	
	15	DGND (for RS232-interface)	

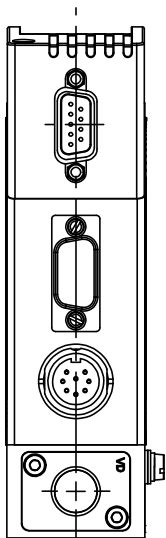

**Fieldbus version**

Socket M16, round, 8 pin	Pin	Assignment
	1	24 V-supply +
	2	Relay 1 – reference contact
	3	Relay 2 – reference contact
	4	Relay 1 – normally closed contact
	5	Relay 1 – normally open contact
	6	24 V-supply GND
	7	Relay 2 – normally open contact
	8	Relay 2 – normally closed contact

Socket D-Sub 9 pin	Pin	Assignment	
		PROFIBUS DP	CANopen
	1	Shield	Shield
	2	Not connected	CAN-L data line
	3	RxD/TxD - P (B-line)	GND
	4	RTS (control signal for repeater)	Not connected
	5	GND	Not connected
	6	VDD (only for termination resistor)	Not connected
	7	Not connected	CAN-H data line
	8	RxD/TxD - N (A-line)	Not connected
	9	Not connected	Not connected

DTS 1000116945 EN Version: J Status: RL (released | freigegeben | valide) printed: 14.03.2022

**Note:**

- Optional Pin 7 and 8 with bus version as transmitter input possible.
- The cable length for RS232/ actual value signal is limited to 30 meters.

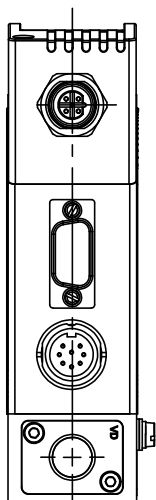

PROFIBUS DP – socket B-coded M12 (DPV1 max. 12 Mbaud)		Pin	Assignment
		1	VDD (only for termination resistor)
		2	RxD/TxD – N (A-line)
		3	DGND
		4	RxD/TxD – P (B-line)
		5	Not connected

CANopen – Plug A-coded M12		Pin	Assignment
		1	Shield
		2	Not connected
		3	DGND
		4	CAN_H
		5	CAN_L

## 5. Product operation

### 5.1. Measuring principle

- The sensor measures the flow by means of differential pressure. An orifice in the main channel causes pressure loss at liquid flow which is measured by the differential pressure sensor. The sensor feedbacks a precise and temperature compensated signal out of which the electronics calculates the corresponding flow.
- To avoid a blockage of the aperture by contaminated mediums an upstream filter is recommended.

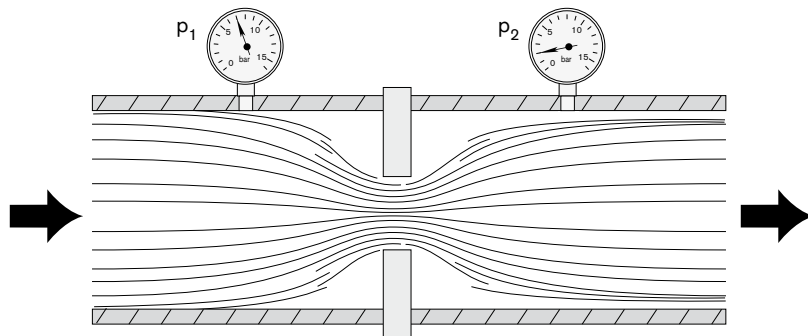

## 6. Ordering information

### 6.1. Bürkert eShop – Easy ordering and quick delivery



#### Bürkert eShop – Easy ordering and fast delivery

You want to find your desired Bürkert product or spare part quickly and order directly? Our online shop is available for you 24/7. Sign up and enjoy all the benefits.

[Order online now](#)

### 6.2. Recommendation regarding product selection

#### Note:

The decisive factors for the perfect functioning of an LFM within the application are the fluid compatibility, the pressure range and the correct choice of the flow meter range. The pressure loss over the LFM averages in typical applications approx. 500 mbar, with up to 2 barg inlet pressure. The specification of the inlet pressure,  $p_{1max}$ , which can be expected is necessary for the selection of the suitable differential pressure sensor.

Please use the „**Product Enquiry Form**“ at the end of this document to indicate the pressures directly before and after the LFM. If these are unknown or not accessible to a measurement, estimates are to be made by taking into account the approximate pressure drops over the flow resistors before and after the LFM, respectively, at a flow rate of  $Q_{Nom}$ . In addition, please quote the maximum inlet pressure  $p_{1max}$  to be encountered. This data is needed to make sure the actuator is able to provide a close-tight function within all the specified modes of operation.

### 6.3. Bürkert product filter



#### Bürkert product filter – Get quickly to the right product

You want to select products comfortably based on your technical requirements? Use the Bürkert product filter and find suitable articles for your application quickly and easily.





















[Try out our product filter](#)



#### 6.4. Ordering chart accessories

**Note:**

The adapters serve mainly for initial operation or diagnosis. Those are not obligatory for continuous operation.

Description	Article no.
<b>Connections/Cables</b>	
Round plug M16, 8 pin (solder connection)	918299 
Round plug M16, 8 pin with 5 m cable	787733 
Round plug M16, 8 pin with 10 m cable	787734 
Plug D-Sub HD15, 15 pin with 5 m cable	787735 
Plug D-Sub HD15, 15 pin with 10 m cable	787736 
<b>Adapters<sup>1.)</sup></b>	
RS232 adapter for connection to a computer, connection with an extension cable (Article no. 917039  )	654757 
Extension cable for RS232 9 pin socket/plug 2 m	917039 
RS422-Adapter (RS485-kompatibel)	666370 
USB-Adapter	670696 
USB connection cable 2 m	772299 
Adapter for manual setting of bus address	667525 
Communication software Mass Flow Communicator	<b>LINK ▶</b>
<b>Accessories for Fieldbus</b>	
<b>PROFIBUS-DP (B-coded)</b>	
Plug M12 <sup>2.)</sup>	918198 
Socket M12 (coupling) <sup>2.)</sup>	918447 
Y-junction <sup>2.)</sup>	902098 
T-junction	918531 
Termination resistor	902553 
GSD-File (PROFIBUS), EDS-File (CANopen)	<b>LINK ▶</b>
<b>CANopen (A-coded)</b>	
Plug M12 <sup>2.)</sup>	917115 
Socket M12 (coupling) <sup>2.)</sup>	917116 
Y-Stück <sup>2.)</sup>	788643 
T-junction	On request
Termination resistor	On request
GSD-File (PROFIBUS), EDS-File (CANopen)	<b>LINK ▶</b>

1.) The adapters serve mainly for initial operation or diagnosis. Those are not obligatory for continuous operation.

2.) The M12 single connectors as listed here are not suitable for their simultaneous use with the Y-piece for reasons of space. Please always use at least one commercially available overmoulded cable whose connector is usually smaller.

### 6.5. Adapter sketch

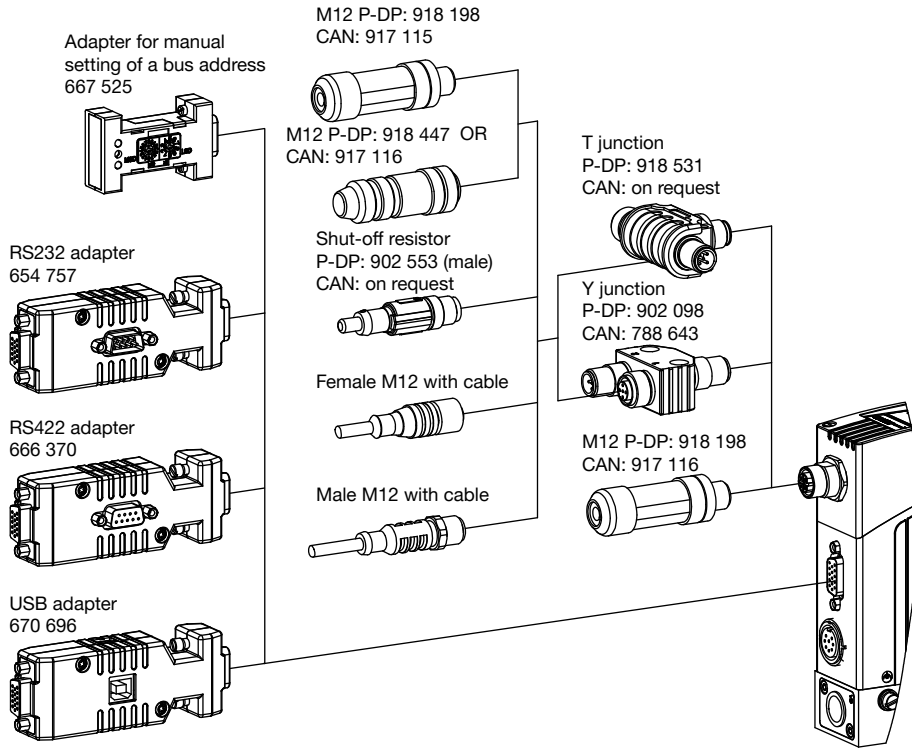

DTS 1000116945 EN Version: J Status: RL (released | freigegeben | valide) printed: 14.03.2022

# Bürkert – Close to You

For up-to-date addresses  
please visit us at  
[www.burkert.com](http://www.burkert.com)

DTS 1000116945 EN Version: J Status: RL (released | freigegeben | validé) printed: 14.03.2022



## Product Enquiry Form - Mass Flow Controller For Fluids

Thank you for your interest in our products! In order to provide you with optimum advice, please fill out the following form and send it to your **Bürkert representative** or e-mail address: [info@burkert.com](mailto:info@burkert.com). All information submitted will of course be kept strictly confidential.

Please fill in the **required fields!**  \*

\*Note: The interactive functions of this PDF may be restricted depending on the PDF reader used.

Personal Information			
Company		Contact person	
Customer no.		Department	
Street		Postcode / Town	
Telephone no.		Email	

Delivery			
MFC Application	MFM Application	Quantity	Required delivery date

Medium data			
Type of liquid or liquid mixture			
Dynamic viscosity	mPas		
Medium temperature	°C	/	°F
Ambient temperature	°C	/	°F

Fluidic data			
Flow range $Q_{Nom}$	Min.	Max.	unit
Inlet pressure at $Q_{Nom}$	$p_1 =$	barg <sup>1.)</sup>	
Outlet pressure at $Q_{Nom}$	$p_2 =$	barg <sup>1.)</sup>	
Max. inlet pressure	$p_{1max} =$	barg <sup>1.)</sup>	
Port connection	Compression fitting	Subbase	Vacuum fitting
	Thread: G (DIN ISO 228/1)	NPT (ANSI B1.2)	1/8" 1/4"
Installation	horizontal, sensor upwards		vertical, upward flow
	horizontal, sensor downwards		vertical, downward flow

1.) Please indicate all pressure values as overpressure to atmospheric pressure [barg] (g = relative pressure)

Material specifications	
Seals	FFKM EPDM

Electrical data		
Control / Communication Note: Please choose <b>one</b> of the following options!	Normsignal	CANopen/büS
	0 ... 5 V	CANopen
	0 ... 10 V	büS
	0 ... 20 mA	
	4 ... 20 mA	

Approvals / Conformities
UL
ATEX II Cat. 3 G/D, IECEx
USP Class VI conformity
FDA conformity
EG 1935/2004 conformity

**Additional Requirements / Comment**

--