

Pressure transmitter with IO-Link interface

- Metallic thin film strain gauge measuring principle
- Process connections: G, NPT in 1/4", G 3/4" with hygienic flush diaphragm or clamp according to DIN 32676
- Measuring ranges for relative pressure from -0.4...+0.4 bar up to -1...+12.0 bar
- Switching functions available : PNP or NPN
- Access to measurement value, device status and settings via IO-Link interface, very easy sensor replacement

Product variants described in the data sheet may differ from the product presentation and description.

Type description

The pressure transmitter measures and monitors relative and absolute (on request) pressure in liquids and gases. The effect of the pressure on the sensor element generates a signal, which is amplified, digitalized, and processed.

Instead of an analogue output this device offers a digital interface IO-Link. This allows bidirectional data transfer with any IO-Link Master. Data access is done by using the available standardized IODD.

The IO-Link is in accordance to the specification version 1.1. IO-Link. The bidirectional communication is used to read process data, diagnostic information, status messages and to set parameters. The two green LEDs are permanently lit as soon as power is supplied to the device. Once an IO-Link connection is established, the LEDs flash.

The switching behaviour and the switching thresholds of the digital outputs (max. 2 pieces; "PNP" or "NPN") can be individually configured – as well as many other parameters.

Table of contents

1. General Technical Data	3
2. Approvals	6
2.1. Pressure Equipment Directive.....	6
Device used on a pipe	6
Device used on a vessel	6
3. Dimensions	7
4. Ordering information	8
4.1. Bürkert eShop – Easy ordering and quick delivery.....	8
4.2. Bürkert product filter.....	8
4.3. Ordering chart.....	8

1. General Technical Data

Product properties	
Material	
Non wetted parts	
Housing	Stainless steel 1.4301 (304)
Wetted parts	
Process connection	Stainless steel 1.4404 (316L)
Measurement element	<ul style="list-style-type: none"> • Membrane in stainless steel 1.4435 (316L) • Welding ring in stainless steel 1.4404 (316L)
Dimensions	Detailed information can be found in chapter “3. Dimensions” on page 7.
Measurement technology	Metallic thin film strain gauge
Measured variable	Relative pressure (absolute pressure on request)
Measuring range	<ul style="list-style-type: none"> • -0.4...+0.4 bar • -1...+1 bar • -1...+2.5 bar • -1...+5.0 bar • -1...+12.0 bar
Compensated ambient temperature range (T_{amb})	-20...+80 °C (-4...+176 °F)
Monitoring	Measuring circuit: IO-Link event configurable and is available as device status <ul style="list-style-type: none"> • Process data invalid • Measuring range overflow • Measuring range underflow • Device hardware fault
Weight	Approx. 160 g
Performance data	
Temperature coefficient (Tc)	
Average Tc of zero	In compensated T° range Version with measuring range <ul style="list-style-type: none"> • -0.4...+0.4 bar: 0.020 %/°C • -1...+1 bar, -1...+2.5 bar: 0.015 %/°C • -1...+5.0 bar, -1...+12.0 bar: 0.010 %/°C
Average Tc of measuring span	Version with measuring range -0.4...+0.4 bar, -1...+1 bar, -1...+2.5 bar, -1...+5.0 bar or -1...+12.0 bar: 0.010 %/°C
Thermal hysteresis	Version with measuring range <ul style="list-style-type: none"> • -0.4...+0.4 bar: 0.15 % of measuring span • -1...+1 bar, -1...+2.5 bar, -1...+5.0 bar, -1...+12.0 bar: 0.10 % of measuring span
Zero offset	Version with measuring range <ul style="list-style-type: none"> • -0.4...0.4 bar: 0.30 % of measuring span • -1...+1 bar, -1...+2.5 bar: 0.15 % of measuring span • -1...+5.0 bar, -1...+12.0 bar: 0.10 % of measuring span
Response time	<ul style="list-style-type: none"> • Digital switching output: ≤ 7 ms • IO-Link: ≤ 9 ms
Measuring resolution	14 bit
Overload limit ¹⁾	Version with measuring range <ul style="list-style-type: none"> • -0.4...+0.4 bar: 1 bar • -1...+1 bar: 4 bar • -1...+2.5 bar: 16 bar • -1...+5.0 bar: 40 bar • -1...+12.0 bar: 100 bar

Burst pressure	Version with measuring range <ul style="list-style-type: none"> -0.4...+0.4 bar: 1.5 bar -1...+1 bar: 8 bar -1...+2.5 bar: 24 bar -1...+5.0 bar: 60 bar -1...+12.0 bar: 150 bar
Measurement deviation	<ul style="list-style-type: none"> At 20 °C²⁾, version with measuring range <ul style="list-style-type: none"> -0.4...+0.4 bar: 0.7 % of measuring span -1...+1 bar: 0.6 % of measuring span -1...+2.5 bar: 0.5 % of measuring span -1...+5.0 bar: 0.5 % of measuring span -1...+12.0 bar: 0.5 % of measuring span At -20 °C...+80°C³⁾, version with measuring range <ul style="list-style-type: none"> -0.4...+0.4 bar: 2.0 % of measuring span -1...+1 bar: 1.8 % of measuring span -1...+2.5 bar: 1.3 % of measuring span -1...+5.0 bar: 1.2 % of measuring span -1...+12.0 bar: 1.0 % of measuring span
Hysteresis	Version with measuring range -0.4...+0.4 bar, -1...+1 bar, -1...+2.5 bar, -1...+5.0 bar or -1...+12.0 bar: 0.05 % of measuring span
Linearity ⁴⁾	Version with measuring range <ul style="list-style-type: none"> -0.4...+0.4 bar, -1...+1 bar, -1...+2.5 bar or -1...+5.0 bar: 0.3 % of measuring span -1...+12.0 bar: 0.25 % of measuring span
Stability ⁵⁾ (per year)	Version with measuring range <ul style="list-style-type: none"> -0.4...+0.4 bar: ≤0.3 % of measuring span -1...+1 bar, -1...+2.5 bar, -1...+5.0 bar or -1...+12.0 bar: ≤0.2 % of measuring span
Behaviour of measuring range (IO-Link specification)	<ul style="list-style-type: none"> Underrange: <ul style="list-style-type: none"> linear up to -1.5 % of measuring span error value: 1×10^{37} Ovrange: <ul style="list-style-type: none"> linear up to 5 % of measuring span error value: 2×10^{37}
Electrical data	
Operating voltage	<ul style="list-style-type: none"> In IO-Link operation: 18...32 V DC, filtered and regulated In switch operation: 9.6...32 V DC, filtered and regulated Nominal voltage: 24 V DC
Power source (not supplied)	The auxiliary energy of the pressure sensor must meet SELV requirements; optionally, an energy-limited current circuit according to section 9.3 of DIN EN 61010-1 and UL 61010-1 can be used.
Current consumption	<ul style="list-style-type: none"> In idle operation: ≤10 mA In IO-Link operation: ≤12 mA In switch operation: ≤250 mA (with two digital outputs)
DC reverse polarity protection	Yes
Overvoltage protection	No
Short circuit protection	Yes (clocked)
Current limiting	Yes
Switching current	≤100 mA per output
Voltage drop at switching transistor	≤2 V DC
Galvanic isolation	To pressure connection available
Signal processing	Input filter: <ul style="list-style-type: none"> digital filter, second order filter time constant can be set

Output signal

Quantity	<ul style="list-style-type: none"> • 1 digital output in IO-Link operation • 2 digital outputs for switch operation (SIO mode; SIO = standard IO)
Switching functions configurable	<ul style="list-style-type: none"> • Hysteresis function (Hysteresis configurable) or window function (fixed setting, symmetrical, $\pm 0.25\%$ of the measuring range) • NC or NO contact • Digital output PNP or NPN • Switch-on/switch-off delay (0...100 s)
Cable	4-wire unshielded cable, max. 20 m

Medium data

Fluid	Liquid and gaseous medium
Fluid temperature	-40...+125 °C (-40...+257 °F)

Process/Port connection & communication

Process connection	<ul style="list-style-type: none"> • G ¼" or NPT ¼" (according to EN 837) • G ¾" flush diaphragm (according to ISO 228-1) • Clamp DN 10/20 (according to DIN 32676) <p>Detailed information on the process connection can be found in chapter "4.3. Ordering chart" on page 8.</p>
Electrical connection	M12 × 1 male connector, 4 pins (A-coded, non rotating)

Digital communication: IO-Link

Communication interface	IO-Link device V1.1, downward compatible to V1.0
Baud rate (data transfer rate)	COM 3 (230.4 kBaud)
Cycle time	Min. 2 ms
IO device description (IODD)	Depending on the ordered measurement range See "Device Description Files" on the website in the Software chapter Type 8318 ▶ or available at https://ioddfinder.io-link.com

Approvals and certificates**Standards**

Degree of protection	IP65 according to DIN EN 60529, with female connector screwed on (for absolute pressure version IP65/IP67)
Protection class	Class III according to EN 61140

Directives

CE directives	The applied standards, which verify conformity with the EU Directives, can be found on the EU Type Examination Certificate and/or the EU Declaration of conformity (if applicable)
Electromagnetic compatibility (EMC)	CE conformity according to EN 61326-2-3 <ul style="list-style-type: none"> • Interference emission: class B • Immunity to interference: to industrial requirements
Pressure equipment directives	<ul style="list-style-type: none"> • The device does not meet the requirements for "safety accessories" within the meaning of the Pressure Equipment Directive 2014/68/EU. • Complying with Article 4, Paragraph 1 of 2014/68/EU directive <p>Detailed information on the pressure equipment directive can be found in chapter "2.1. Pressure Equipment Directive" on page 6.</p>

Environment and installation

Ambient temperature	-40...+85 °C (-40...+185 °F) (operation and storage)
Relative air humidity	<ul style="list-style-type: none"> • During operation: $\leq 100\%$, without condensation on the outer housing surface of the device • During storage: $\leq 90\%$, without condensation
Climate class	3K7 according to EN 60721-3-3
Area of use	Indoors and outdoors (protect this device against electromagnetic interference, ultraviolet rays and the effects of climatic conditions)
Vibration resistance	10 g max. with 10...2000 Hz according to EN 60068-2-6
Shock resistance	<ul style="list-style-type: none"> • 20 g, 11 ms according to EN 60068-2-27 • 50 g, 1 ms according to EN 60068-2-27
Mounting position	<ul style="list-style-type: none"> • Installation: unrestricted • Calibration: device upright, process connection at the bottom

1.) All sensors are vacuum proof.

- 2.) Includes linearity, hysteresis, repeatability, deviation of measuring range initial value and measuring range end value
- 3.) Includes linearity, hysteresis, repeatability, deviation of measuring range initial value, measuring range end value, thermal effect on measuring range start and measuring span
- 4.) Linearity according to limit point setting
- 5.) Reference conditions EN 61298-1

2. Approvals

2.1. Pressure Equipment Directive

The device conforms to Article 4, Paragraph 1 of the Pressure Equipment Directive 2014/68/EU under the following conditions:

Device used on a pipe

Note:

- The data in the table is independent of the chemical compatibility of the material and the fluid.
- PS = maximum admissible pressure, DN = nominal diameter of the pipe

Type of fluid	Conditions
Fluid group 1, Article 4, Paragraph 1.c.i	$DN \leq 25$
Fluid group 2, Article 4, Paragraph 1.c.i	$DN \leq 32$ or $PS \cdot DN \leq 1000$
Fluid group 1, Article 4, Paragraph 1.c.ii	$DN \leq 25$ or $PS \cdot DN \leq 2000$
Fluid group 2, Article 4, Paragraph 1.c.ii	$DN \leq 200$ or $PS \leq 10$ or $PS \cdot DN \leq 5000$

Device used on a vessel

Note:

- The data in the table is independent of the chemical compatibility of the material and the fluid.
- PS = maximum admissible pressure, V = vessel volume

Type of fluid	Conditions
Fluid group 1, Article 4, Paragraph 1.a.i	$V > 1 \text{ L}$ and $PS \cdot V \leq 25 \text{ bar} \cdot \text{L}$ or $PS \leq 200 \text{ bar}$
Fluid group 2, Article 4, Paragraph 1.a.i	$V > 1 \text{ L}$ and $PS \cdot V \leq 50 \text{ bar} \cdot \text{L}$ or $PS \leq 1000 \text{ bar}$
Fluid group 1, Article 4, Paragraph 1.a.ii	$V > 1 \text{ L}$ and $PS \cdot V \leq 200 \text{ bar} \cdot \text{L}$ or $PS \leq 500 \text{ bar}$
Fluid group 2, Article 4, Paragraph 1.a.ii	$PS > 10 \text{ bar}$ and $PS \cdot V \leq 10000 \text{ bar} \cdot \text{L}$ or $PS \leq 1000 \text{ bar}$

3. Dimensions

Note:

Dimensions in mm

With G 1/4" process connection according to EN 837

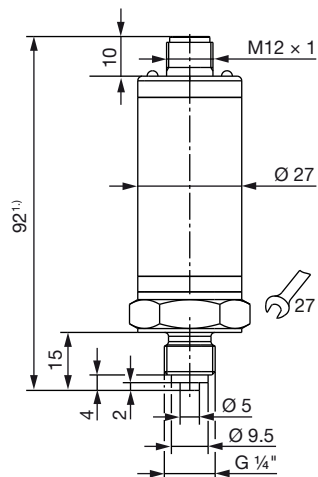

With NPT 1/4" process connection according to EN 837

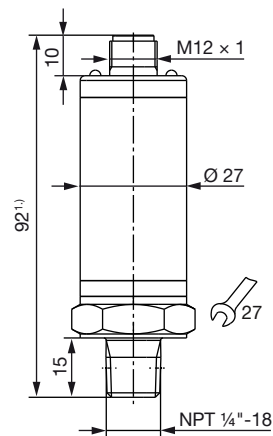

With G 3/4" front-flush process connection according to ISO 228-1

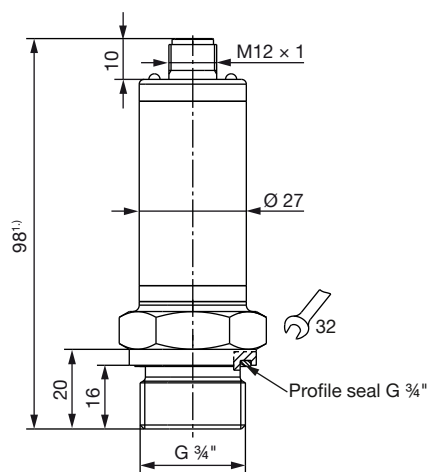

With clamp DN10/20 process connection according to DIN 32676

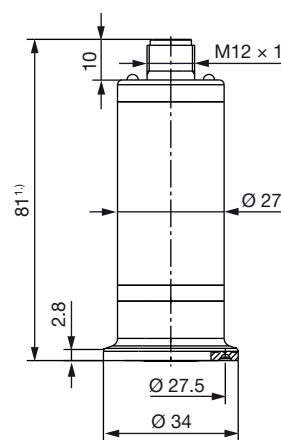

1.) The total height is increased by the height of the used female connector and cable .

4. Ordering information

4.1. Bürkert eShop – Easy ordering and quick delivery



Bürkert eShop – Easy ordering and fast delivery

You want to find your desired Bürkert product or spare part quickly and order directly? Our online shop is available for you 24/7. Sign up and enjoy all the benefits.

[Order online now](#)

4.2. Bürkert product filter



Bürkert product filter – Get quickly to the right product

You want to select products comfortably based on your technical requirements? Use the Bürkert product filter and find suitable articles for your application quickly and easily.





















[Try out our product filter](#)

4.3. Ordering chart

Note:

All these versions have

- an operating voltage depending on operation mode (IO-Link: 18...32 V DC, Switch: 9.6...32 V DC or Nominal: 24 V DC)
- an IO-Link digital interface (according to specification version 1.1) or digital outputs (SIO mode; SIO = standard IO)

Process connection	Pressure range (relative pressure)	Burst pressure (relative pressure)	Article no.
	[bar]	[bar]	
G ¼" according to EN 837	-0.4...+0.4	1.5	574614 
	-1...+1	8	574615 
	-1...+2.5	24	574616 
	-1...+5	60	574617 
	-1...+12	150	574618 
NPT ¼" according to EN 837	-0.4...+0.4	1.5	574619 
	-1...+1	8	574620 
	-1...+2.5	24	574621 
	-1...+5	60	574622 
	-1...+12	150	574623 
Clamp DN 10/20 according to DIN 32676	-0.4...+0.4	1.5	574624 
	-1...+1	8	574625 
	-1...+2.5	24	574626 
	-1...+5	60	574627 
	-1...+12	150	574628 
G ¾" flush diaphragm according to ISO 228-1	-0.4...+0.4	1.5	574629 
	-1...+1	8	574630 
	-1...+2.5	24	574631 
	-1...+5	60	574632 
	-1...+12	150	574633 

Further versions on request

**Process connection**

- G ½" according to EN 837
- G ¼" and G ½" according to DIN3852-11
- Clamp DN 25/32/40 (50.5 mm) and clamp DN 50 (64 mm) according to DIN 32676

**Pressure**

- Relative pressure: up to 600 bar or 8700 PSI
- Absolute pressure: up to 100 bar or 1450 PSI

Bürkert – Close to You

For up-to-date addresses
please visit us at
www.burkert.com

DTS 1000416952 EN Version: A Status: RL (released | freigegeben | validé) printed: 13.01.2021

