

## Modular analysis transmitter for pH/ORP, conductivity measurement

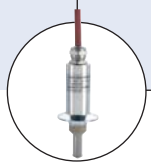

Type 8285 can be combined with...



**Type 8221**  
Conductivity sensor

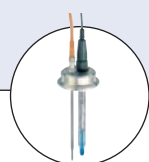

**Type 8200**  
pH sensor

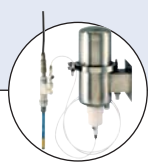

**Type 8201**  
Enamel pH sensor



**Type 2031**  
On/Off Diaphragm valve

- High flexibility provided by modular concept for several measuring parameters
- Outstanding features for highly demanding applications
- Simple and intuitive user interface supported by a large high-resolution graphic display
- Compatible with most common pH and conductivity sensor types

The 8285 modular process analysis system is designed to measure and process liquid analysis parameters. The base unit contains the power supply, signal outputs, binary inputs and the front with graphic display with backlighting. Three slots are available, which depending on the applications can be occupied with modules for pH, conductivity or also with a module with additional outputs.

The hygienic, polished stainless steel enclosure version allows application in the field of biotechnology, food processing, and in the pharmaceutical industry. Further applications in the chemical industry, environmental engineering, water and waste-water treatment, and for application in power plants are also possible.

Technical data - Base unit	
<b>General data</b>	
<b>Mounting</b>	Wall, post/pipe, panel mounting, sealed against panel
<b>Materials</b>	
Housing, cover	Stainless steel, polished 1.4305
Vision panel / Screws / Glands	Polycarbonate / Stainless steel / PA
<b>Weight</b>	Approx. 3.2 kg + approx. 150 g per module
<b>Display <sup>1)</sup></b>	LC graphic display, white backlighting 240 x 160 pixels resolution; German, English, French, Italian, Spanish, Swedish languages
<b>Keypad</b>	NAMUR keypad, individual keys, no double assignments [meas] [menu][↑] [↓] [→] [←] [enter] [softkey1] [softkey2], NAMUR LEDs red and green
<b>Logbook</b>	Recording of function activations, appearance and disappearance of warning and failure messages, with date and time
Storage capacity standard	Approx. 50 entries, without SMARTMEDIA® Card read on display, recording on SMARTMEDIA® card
Extended logbook (option Item no. 558 083)	> 50 000 entries, depending on free memory of SMARTMEDIA® card
<b>Measurement recorder</b> (option Item no. 558 083)	2-channel measurement recorder with marking of events (failure, maintenance request, function check, limit values)
Recording medium	SMARTMEDIA® card
Recording capacity	> 50 000 entries, depending on free memory of SMARTMEDIA® card
Recording	Process variables and span selectable
Recording method	Snapshot, min/max or mean value, average
Time base	10 s...10 h
Zoom function	10 fold zoom in the event of high rate of change
<b>Sensor monitor</b>	Direct display of measured values from sensor for validation
<b>KI recorder</b> (option Item no. 558 074)	Adaptive representation of process flow with monitoring and signalling of critical process parameters

<sup>1)</sup> Caution! Never expose the display to direct sun light! Only operate the display within the temperature range of 0 up to 50°C max.

**Technical data - Base unit (continued)**

General data (continued)	
<b>Device self-test</b>	Test of RAM, FLASH, EEPROM, display and keypad, record for QM documentation to ISO 9000
<b>Clock</b>	Real-time clock with date; Power reserve: approx. 1 year (lithium battery)
<b>Data retention in case of power failure</b>	Parameters and factory settings > 10 years (EEPROM) Logbook, statistics, records > 1 year (lithium battery) Measurement recorder SMARTMEDIA® card
<b>Module slots</b>	3
<b>Electrical connection</b>	Terminals via 5 x M20 x 1.5 cable glands
<b>Connection cable</b>	Single wires and flexible leads up to 2.5 mm <sup>2</sup> (AWG 14) Ground wire: 2.5 mm <sup>2</sup> , screw M4 (EN 61010-1, 6.5.1.2)
Electrical data	
<b>Power supply</b>	24 (-15%)...230 (+15%) V AC/DC; approx. 10 VA/10 W
Overvoltage category	II
Protection class	I
Pollution degree	2 (EN 61010-1)
<b>Protection against electrical shock</b>	Protective connection according to EN 61010-1, 6.5.1
<b>Binary input OK 1</b>	Galv. separated (OPTO coupler); $V_i \leq 30$ V, floating, galvanic isolation up to 60 V switches the device to HOLD mode (function check)
Function	
Switching voltage	0...2 V AC/DC inactive, 10...30 V AC/DC active (invertible)

**Electrical data (continued)**

<b>Binary input OK 2</b>	Galv. separated (OPTO coupler); $V_i \leq 30$ V, floating, galvanic isolation up to 60 V START/STOP KI recorder, switch over to second parameter set
Function	
Switching voltage	0...2 V AC/DC inactive, 10...30 V AC/DC active (invertible)
<b>Current output I1</b>	0/4...20 mA (22 mA), max. 10 V, galvanic isolation up to 60 V (galvanically connected with output I2) Error message if load is exceeded
Load monitoring	22 mA in the case of a message
Overrange*	< 0.2% current value + 0.02 mA
Signal deviation <sup>1)</sup>	0.00...22.00 mA
Current source	
<b>Current output I2</b>	0/4 ... 20 mA (22 mA), max. 10 V, galvanic isolation up to 60 V (galvanically connected with output I1) Error message if load is exceeded
Load monitoring	22 mA in the case of a message
Overrange*	< 0.2% current value + 0.02 mA
Signal deviation <sup>1)</sup>	0.00 ... 22.00 mA
Current source	
<b>Switching contacts*</b>	4 relay contacts K1 ... K4, floating, galvanic isolation up to 60 V K1, K2, K3 are connected on one side DC: < 30 V / < 500 mA, < 10 W K1 - K3, user definable for NAMUR maintenance request /function check, limit values, parameter set 2 active, rinsing contact, USP contact, K4 permanently set as alarm contact (NAMUR failure)
Loadability	
Application*	

\* User-defined

<sup>1)</sup> To IEC 746 Part 1, at nominal operating conditions
**Technical data - 8285 pH/ORP module**

<b>pH/ORP input</b>	simultaneous pH and ORP measurement with several types of electrodes: - Input for pH/ORP glass electrode (type 8200) - Input for enamel coated pH electrodes (type 8201)	<b>ORP*</b>	Automatic conversion to standard hydrogen electrode SHE when type of reference electrode is entered
Measurement range		<b>Sensor standardization ORP*</b>	Zero adjustable from -200...+200 mV
pH value	-2.00...+16.00	<b>Sensor standardization pH</b>	1-/2-/3-point calibration (best fit line) Operating modes: •Calimatic® automatic buffer recognition •Input of individual buffer values •Product calibration •Data entry of premeasured electrodes Fine / standard / coarse •Fixed buffer sets: 1- Knick/Mettler-Toledo; 2- Merck/Riedel; 3- DIN 19267; 4- NIST Standard; 5- Technical buffers to NIST; 6- Hamilton buffers •Manually enterable buffer set with max. three buffer tables (additional function Item no. 558 075) pH 0 ... 14; calibration range $\Delta$ pH = $\pm$ 1 25 ... 61 mV/pH; calibration range 80...103 % -1000...+1000 mV
ORP value	-2000...+2000 mV	Drift check*	
rH value	0.0...42.5	Calimatic® buffer sets*	
Adm. voltage ORP + pH	2000 mV		
Adm. cable capacitance	< 2 nF		
Glass electrode input <sup>1)</sup>	Input resistance: > $1 \times 10^{12} \Omega$ Input current <sup>2)</sup> : < $1 \times 10^{-12}$ A Input range: 0.5 ... 1000 M $\Omega$		
Ref. electrode input <sup>1)</sup>	Input resistance: > $1 \times 10^{10} \Omega$ Input current <sup>2)</sup> : < $1 \times 10^{-10}$ A Input range: 0.5...200 k $\Omega$		
Signal deviation <sup>1) 2)</sup> (Display)	pH value: < 0.02 ; TC < 0.001 pH/K ORP value: < 1 mV ; TC < 0.05 mV/K		
<b>Temperature input</b>	Pt100 / Pt1000 / NTC30 k $\Omega$ / NTC 8.55 k $\Omega$ 3-wire connection, adjustable	Nom. zero*	
Measurement range	-20...+150°C (Pt100/Pt1000/NTC30 k $\Omega$ ) -10...+130°C (NTC 8.55 k $\Omega$ , Mitsubishi)	Nom. slope (25°C)*	
Resolution	0.1°C	Uiso*	
Signal deviation <sup>1) 2)</sup>	0.2% meas. value + 0.5 K (< 1 K with NTC > 100°C)	<b>Calibration record</b>	Recording of: Zero point, slope, Uiso, response time, calibration process with date and time

## Technical data - 8285 pH/ORP module (continued)

<b>Statistics</b>	Recording of: Zero, slope, Uiso, response time, glass and reference impedance with date and time of the last three calibrations and the First Calibration	<b>Sensor monitor</b>	Direct display of measured values from sensor for validation pH input / ORP input / glass el. impedance / ref. el. impedance / RTD / temperature
<b>Sensocheck®</b>	Automatic monitoring of glass and reference electrode, message can be switched off	<b>KI recorder</b> (option Item no. 558 074)	Adaptive representation of process flow with monitoring and signalling of critical process parameters
<b>Sensoface®</b>	provides information on the sensor condition: Zero/slope, response time, calibration interval, Sensocheck®, CalCheck® (can be disabled)	<b>Adaptive calibration timer*</b>	Automatic adjustment of calibration interval (Sensoface® signal), depending on measured values
<b>CalCheck®</b>	Monitoring of electrode calibration range during measurement	<b>ServiceScope**</b> (option Item no. 558 076)	Monitoring the inputs for overdrive Representation on display
<b>Sensor network diagram</b>	Graphical representation of current sensor parameters in a network diagram on the display: Slope, zero, reference impedance, glass impedance, response time, cal timer, deviation from calibration range (CalCheck®)	<b>Tolerance adjustment</b> (option Item no. 558 077)	Tolerant calibration/adjustment, tolerance limits adjustable, graphical recording of zero point and slope of the last 40 calibrations

\* User-defined

<sup>1)</sup> To IEC 746 Part 1, at nominal operating conditions<sup>2)</sup> ± 1 count, plus sensor error<sup>3)</sup> At 20°C, doubles every 10 K

## Technical data - 8285 conductivity module

<b>Conductivity input</b>	Operation with 2- or 4-electrode sensors Conductivity 0.000 µS/cm ... 1999 mS/cm Resistivity 0.5 Ω.cm ... 999 MΩ.cm Concentration 0.00 ... 100.0% by wt Salinity 0.0 ... 45.0 g/kg (0 ... 35°C) Measurement range* 4EL sensors: 0.1 µS.c to 2000 mS.c <sup>3)</sup> 2EL sensors: 0.1 µS.c to 200 mS.c <sup>3)</sup> Display ranges Resolution depending on cell constant Cell constant Resolution of conductivity < 0.1200 cm <sup>-1</sup> 0 µS/cm < 1.200 cm <sup>-1</sup> 00.00 µS/cm < 12.00 cm <sup>-1</sup> 000.0 µS/cm < 120.0 cm <sup>-1</sup> 000.0 µS/cm ≥ 120.0 cm <sup>-1</sup> 00.00 mS/cm Response time (T90) Approx. 1 sec Signal deviation <sup>1) 2)</sup> < 0.5 % meas. val. + 0.2 µS.c <sup>3)</sup>	<b>Concentration determination*</b> (option Item no. 558 080)	for the substances: HNO <sub>3</sub> 0...28 % by wt -20...+50°C 35...96 % by wt -20...+50°C HCl 0...18 % by wt -20...+50°C 22...39 % by wt -20...+50°C H <sub>2</sub> SO <sub>4</sub> <sup>4)</sup> 0...30 % by wt -17.8...+110°C 32...84 % by wt -17.8...+115.6°C 92...99 % by wt -17.8...+115.6°C NaOH <sup>5)</sup> 0...14 % by wt 0...+100°C 18...50 % by wt 0...+100°C NaCl 0...26 % by wt 0...+60°C User-defined concentration chart (5x5x5 values)
<b>Temperature input</b>	Pt100 / Pt1000 / NTC30 kΩ / Ni 100 3-wire connection, adjustable Measurement range Pt100 / Pt1000: -50 ... +250°C NTC 30 kΩ: -10 ... +150°C Ni 100: -50 ... +180°C Resolution 0.1°C Signal deviation <sup>1) 2)</sup> 0.2 % meas. val. + 0.5 K	<b>Sensor monitoring*</b>	Sensocheck®; Polarization and cable capacitance
<b>Temperature compensation*</b> (option Item no. 558 079)	- Linear characteristic 00.00 ... 19.99 %/K (reference temp user-defined) - (NLF nat. waters to EN 27888 <sup>W)</sup> - Ultrapure water with NaCl traces (0 ... 120°C) <sup>W)</sup> - Ultrapure water with HCl traces (0 ... 120°C) <sup>W)</sup> - Ultrapure water with NH3 traces (0 ... 120°C) <sup>W)</sup> - Ultrapure water with NaOH traces (0 ... 120°C) <sup>W)</sup> <sup>W)</sup> for all waters: Reference temp 25°C	<b>Sensoface®</b>	provides information on the sensor condition
		<b>Sensor standardization*</b>	Operating modes - Autom. calibration with KCl or NaCl solution - Manual: Entry of conductivity - Product calibration / adjustment to vessel - Entry of cell constant with simultaneous display of conductivity and temperature 0.0050 ... 199.99 cm <sup>-1</sup> Recording of: Cell constant, calibration method, with date and time
		<b>Output curves*</b>	Linear; Trilinear; Function (logarithmic); As desired via chart
		<b>USP function</b>	Water monitoring in the pharmaceutical industry (USP) with possibility to enter a limit value (%) Output via relay contact (K1...K3, BASE) possible

\* User-defined

<sup>1)</sup> To IEC 746 Part 1, at nominal operating conditions<sup>2)</sup> ± 1 count, plus sensor error<sup>4)</sup> measurement limits at 27°C<sup>3)</sup> c = 0.0050 ... 199.99 cm<sup>-1</sup><sup>5)</sup> measurement limits at 25°C

**Technical data** - output module

<b>Current output I3 (passive)</b> Supply voltage Load monitoring Overage* Measurement error** Start/end of scale* Current source	0/4 ... 20 mA (22mA), floating (electrically connected with output I4) 3 ... 30 V, $I_{max} = 100 \text{ mA}$ , $P_{max} = 0.8 \text{ W}$ Error message if load is exceeded 22 mA in the case of a message $< 0.25 \%$ current value $+0.05 \text{ mA}$ As desired within the range 0.00 ... 22.00 mA	<b>Threshold outputs K5 - K8</b> Voltage drop Loadability	4 electronic relay outputs, polarized floating, inter-connected $< 1.2 \text{ V}$ DC: $V_{max} = 30 \text{ V}$ ; $I_{max} = 100 \text{ mA}$ ; $P_{max} = 0.8 \text{ W}$
<b>Current output I4 (passive)</b> Supply voltage Load monitoring Overage* Measurement error* Start/end of scale Current source	0/4 ... 20 mA (22mA), floating (electrically connected with output I3) 3 ... 30 V, $I_{max} = 100 \text{ mA}$ , $P_{max} = 0.8 \text{ W}$ Error message if load is exceeded 22 mA in the case of a message $< 0.25 \%$ current value $+0.05 \text{ mA}$ As desired within the range 0.00 ... 22.00 mA	<b>Screw clamp connector</b>	Single wires and flexible leads up to $2.5 \text{ mm}^2$

\* User-defined

\*\* To IEC 746 Part 1, at nominal operating conditions

**Environment and Standard data** - common to base unit, pH/ORP, conductivity modules

<b>Ambient temperature</b> Operation Storage	-20 to $+55^\circ\text{C}$ (Ex: max. $50^\circ\text{C}$ ) -20 to $70^\circ\text{C}$ (limited through the electrode)	<b>Protection class</b>	IP65 / NEMA 4X
<b>Relative humidity</b>	10 ...95%, without condensation	<b>Standard EMC</b>	NAMUR NE 21, EN 61326 VDE 0843 Part 20 /01.98, EN 61326/A1 VDE 0843 Part 20/A1 /05.99
		Emitted interference Immunity to interference Lightning protection	Class B Industry EN 61000-4-5, Installation Class 2

Phase out

**System overview**

**A modular concept: base unit, measuring module, additional functions**

The Type 8285 is an expendable modular process analysis system. The base unit provides three slots which can be equipped by the user with any combination of measuring or communication modules. The software capabilities can be expanded by additional functions (options). Additional functions must be ordered separately. They are supplied with a device-specific TAN for function release.

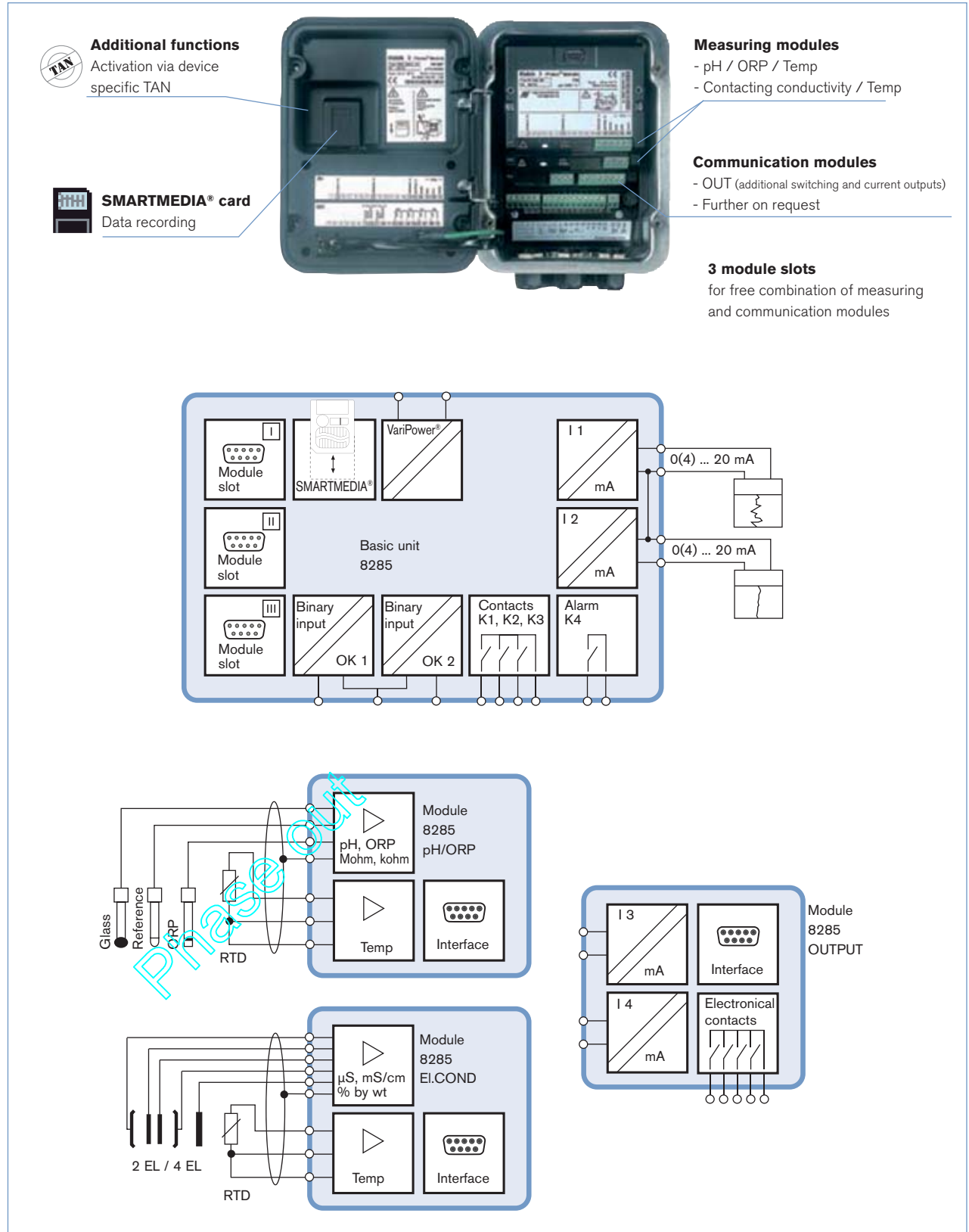

## Modules

### The modules: universally interchangeable

Various user-defined plug-in measuring modules for measurement and control functions can be combined depending on the measuring task. They also facilitate subsequent trouble-free expansion or modification.

Communication module for functional expansions: the OUT module for the expansion of the output options is available.

If necessary, it can also record several measurement parameters in any combination with one device; pH/pH, Cond/Cond etc. or e.g. simultaneous pH and conductivity measurement.

Combined evaluation - i.e. the calculation of several measuring parameters e.g. for differential measurement or quasi-redundant measuring systems. Up to 3 measuring modules can be combined.

Plug & Play - the modules are simply clicked into place in the slots provided, in any order. The modules are automatically recognized. Very straight forward retro-fitting or modification; hot-swap technology.

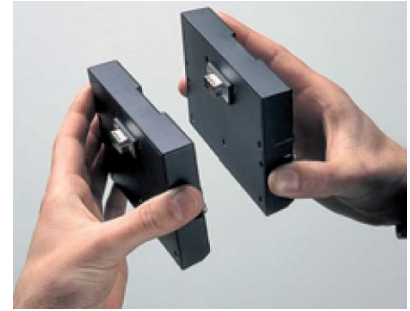

## The functions

### Progress in perfection

In addition to excellent features such as the universally used VariPower® 20 to 265 V AC/DC power supply, the time and event controlled 2-channel measurement recorder, the Sensocheck® sensor monitoring and the Calcheck® monitoring of the measured value distance between calibration, the Type 8285 system can be further expanded with pioneering functions such as:

#### 1. Early alarm detection with the KI recorder (option).

The KI recorder follows the course of the process and releases a message in the event of abnormalities. The monitoring is always carried out for the primary measured variable, e.g. pH or conductivity and parallel to that for the temperature. The visualization is graphical with the process and limit value variation for both variable.

#### 2. Checking of batch processes using the KI recorder (option).

The KI recorder records the course of a batch (self-teaching function). All further batches are then monitored for deviations from the saved course.

#### 3. Sensor network diagram for pH measurement (standard).

Graphical representation of the current sensor parameters on the display in a network diagram with slope, zero point, reference impedance, glass impedance, response time, calibration timer, deviation from calibration range (Calcheck®).

#### 4. ServiceScope® (option).

monitors whether the pH input signal lies within the input control range. Moreover, the representation of the noise level over the time allows the distinction to be made between individual disturbances, periodic and broadband disturbances which is helpful for troubleshooting. In this way, it is possible to check whether regularly recurring disturbances, e.g. large consumers, which are regularly switched on or off can be simply detected. An error message is generated if the noise level exceeds the failure limit.

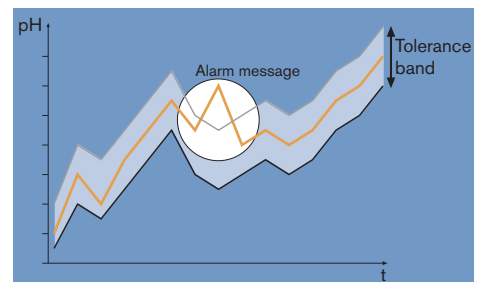

KI recorder (1)

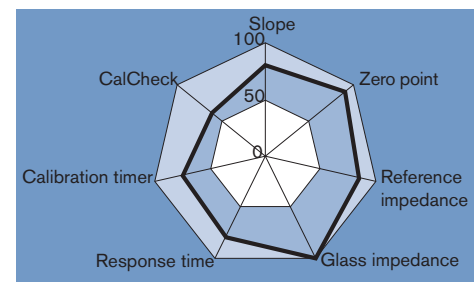

Sensor network diagram (3)

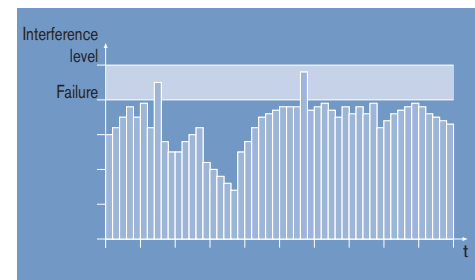

ServiceScope® (4)

## SMARTMEDIA®



### For parameters and the recording of data

- 5 parameter sets can be filed and loaded into the device
- A parameter set contains all parameter data, facilitating rapid exchange and speedy complete parameter setting. Simple return to factory settings.
- Almost unlimited expansion of the measurement recorder
- Parameter sets can be transferred from one device to another. This removes the need for the tire some repetition of inputting parameters.
- The device parameters can be completely saved on a SMARTMEDIA® card and then archived directly or on a PC
- Extended logbook

SMARTMEDIA® is a registered trademark of the Toshiba Corp. Japan

### Everything on a card

The SMARTMEDIA® card (measuring only 4.5 by 3.7 cm and only 1 mm thick) is an extremely compact, very widely used memory expansion medium available to the 8285 system. The SMARTMEDIA® card is already a global standard in such diverse fields of digital data processing as MP3 players and digital cameras. This means that the SMARTMEDIA® card can be connected via the very inexpensive, commercially available adapter to RS232C, USB etc. or directly via a PCMCIA adapter to any PC.

### For software updates and software functions

- Contains the complete 8285 software
- Software functions can be installed at a later date and disconnected via transaction numbers (TAN)
- Software updates to keep 8285 upgraded with the latest software – on request.

Simple operation:

Simply insert the SMARTMEDIA® card into the small slot on the rear of the front door.



Phase out

Display and menu structure

**4 captive screws**

for opening the transmitter  
**(Caution!** Make sure that the gasket between FRONT and BASE is properly seated and clean!)

**2 Softkeys**

with context-sensitive functions

**Control panel**

3 function keys (menu, meas, enter) and 4 arrow keys for menu selection and data entries

**Transflective LC graphic display**

(240 x 160 pixels) white backlighting, high resolution and high contrast

**Measurement display**

**User interface**

with plaintext menus as recommended by NAMUR.  
 Menu texts can be switched to German, English, French, Italian, Swedish, and Spanish.  
 Intuitively acquirable menu logic, based on Windows standard.

**Secondary displays**

**Red LED**

signals failure (On) or maintenance request/function check (flashing) according to NE 44

**Green LED**

Voltage supply okay

**5 self-sealing cable glands**

M20 x 1.5  
 for entry of voltage supply and signal lines

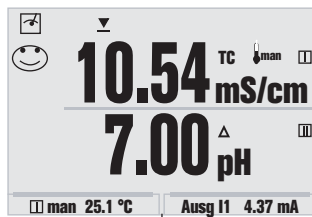

The menu key can be used to access the individual submenus via the function keys.

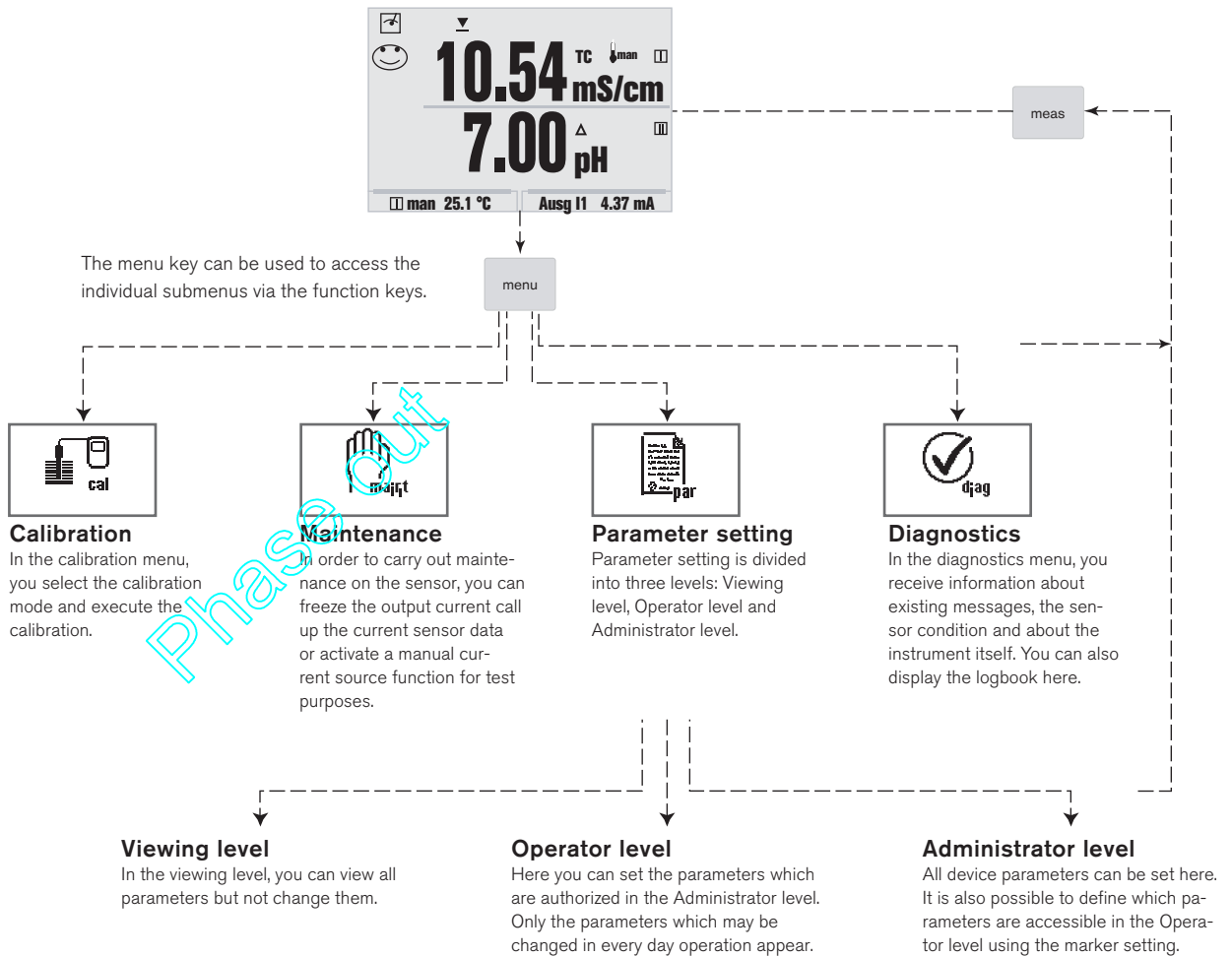



Dimensions [mm]

Front view

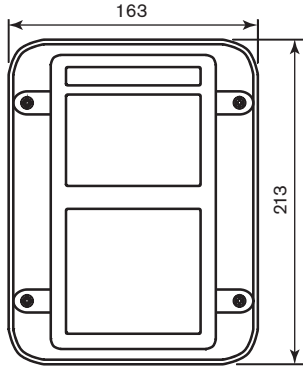

Side view

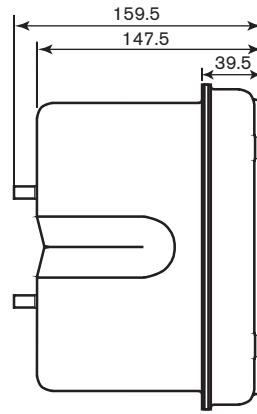

Rear view

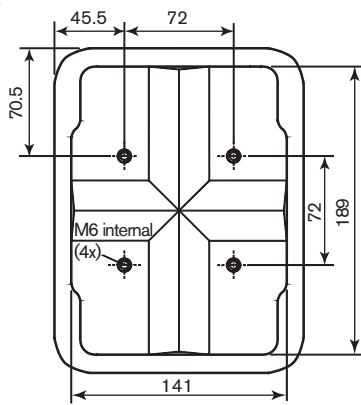

Control panel cutout

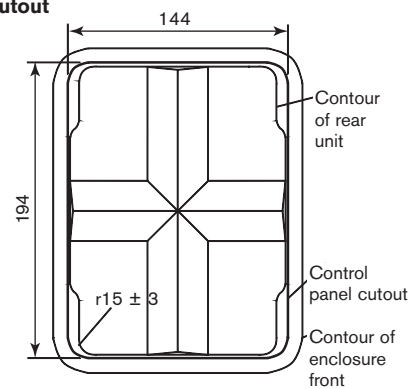

Wall mounting

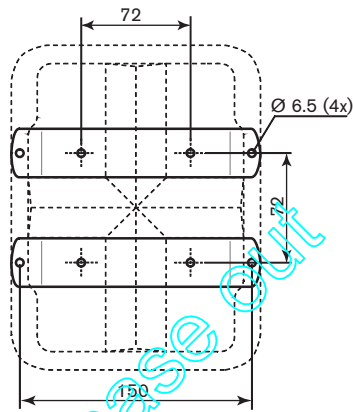

Post/pipe mounting

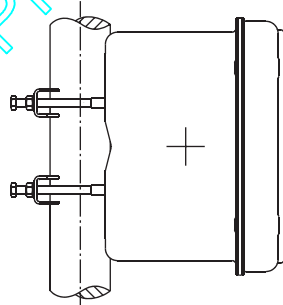
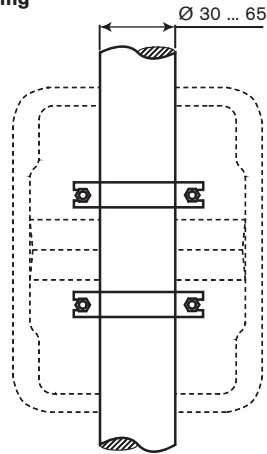

Ø 30 ... 65 mm for vertical or horizontal mounting

		M6x50	M6x70
Ø 30 ... 65 mm	X		
Ø 30 ... 40 mm	X		
Ø 40 ... 62 mm			X
Ø 62 ... 65 mm			X without nut

## Ordering chart for modular analysis transmitter Type 8285

Description	Item no.
Modular analytical transmitter: BASE unit	557 720
Modular analytical transmitter: CONDUCTIVITY module	557 736
Modular analytical transmitter: pH/ORP module	558 073
Modular analytical transmitter: OUTPUT module* (Passive 4-20 mA output, common minus)	559 088

\* NOTE: if the two 4-20 mA output of the OUTPUT module are connected to a PLC which has common minus too, then it is necessary to use an galvanic insulator (see page 11).

## Ordering chart for accessories for transmitter Type 8285

Description	Item no.
<b>Additional functions: SMARTMEDIA® card not necessary</b>	
KI recorder (pH only)	558 074
Additional sets of buffer solutions (pH only)	558 075
Servivescope (pH only)	558 076
Tolerance band recorder (pH only)	558 077
Current output curve freely programmable	558 078
Temperature compensation ultra-pure water (conductivity only)	558 079
Concentration measurement (conductivity only)	558 080
<b>Additional functions: SMARTMEDIA® card included</b>	
Additional 5 loadable parameters sets	558 081
Data recorder	558 082
Extended logbook	558 083
Software update	558 084
Electronic data recording according to FDA CFR Part 11	558 085
<b>SMARTMEDIA® card</b>	
SMARTMEDIA® card 128 MB	558 086
AuditTrail Card (for recording acc. to FDA: replacement card)	558 087
Diagnosis card	558 088
<b>Mounting accessories</b>	
Pipe mounting set	558 089
Panel mounting set	558 090
Protective roof	558 091
Adapter set M20 x 1.5 to NPT 1/2" (2 pieces per set)	551 782

SMARTMEDIA® is a registered trademark of the Toshiba Corp. Japan

CalCheck®, Calimatic®, Sensocheck®, Sensoface®, ServiceScope®, Varipower® are registered trademark of the Knick GmbH & Co. KG, Germany

## Current signal insulator

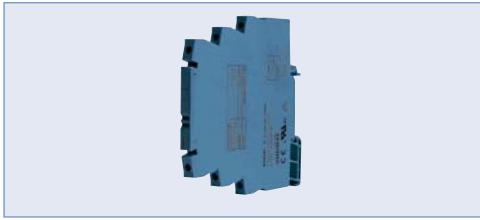

- Power supply to a 2-wire transmitter and galvanically isolated transmission of the measured signal in the 4 ... 20 mA range.
- mounted on standard TS 35 rails and fixed in position by a suitable end bracket

General data	
<b>Enclosure</b>	Modular case
<b>Mounting</b>	35 mm top-hat rail to EN 50022
<b>Wire cross-section</b>	single wire or finely stranded 0.5 ... 2.5 mm <sup>2</sup> with ferrule 0.5 ... 1.5 mm <sup>2</sup>
<b>Weight</b>	Approx. 50 g
<b>Gain error</b>	< 0.1 % meas. val..
<b>Response time</b>	< 5 ms
<b>Temperature influence</b>	< 0.005 %/K final value (average TC, reference temp 23 °C)

Environment and standard data	
<b>Ambient Temperature</b>	Operating: 0 up to +55°C Storage: -25 up to +85°C
<b>Ingress protection</b>	IP 20
<b>EMC<sup>1)</sup></b>	Product standard: EN 61326 Emitted interference: Class B Immunity to interference: industry

<sup>1)</sup> Minor deviations possible during interference

## Dimensions [mm]

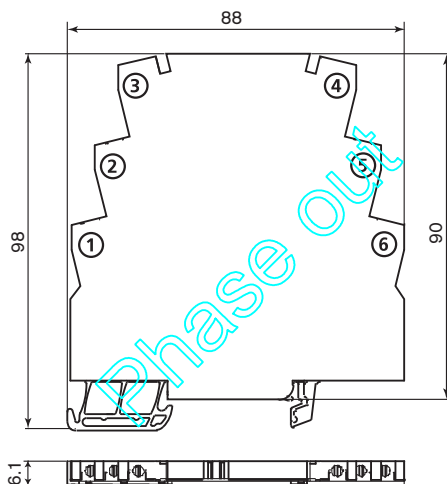

No.	Assignments
1	Current loop +
2	Current loop -
3	power supply -
4	power supply +
5	output -
6	output +

Electrical data	
<b>Power supply</b>	24 V DC (±15 %), approx. 1 W Power supply can be led from one unit to the other via a pluggable cross-connection.
<b>Galvanic isolation</b>	1.5 kV AC input (current loop) against output / power supply 510 V AC output against power supply
<b>Test voltage</b>	Approx. 50 g
<b>Working voltage (basic insulation)</b>	Up to 300 V AC/DC across input (current loop) and output / power supply, for overvoltage category II and pollution degree 2. Up to 100 V AC/DC across output and power supply for overvoltage category II and pollution degree 2 to EN 61010-1 For applications with high working voltages take measures to prevent accidental contact and make sure that there is sufficient distance to adjacent devices or sufficient insulation between them.
<b>Input data</b>	Input (Current loop)
	Supply voltage 16.5 V, constant for 3 ... 22 mA, short-circuit-proof current limited to 25 mA max.
	Residual ripple < 10 mV <sub>rms</sub>
<b>Output data</b>	Output
	Output signal in case of short circuit at input: 4 ... 20 mA
	Output signal in case of open input: 22 ... 25 mA
	Load: < 3 mA
	Load: ≤ 10 V (≤ 500 Ohms at 20 mA)
	Offset: < 30 μA
	Residual ripple: < 10 mV <sub>rms</sub>

## Ordering chart current signal insulator

Specifications	IN	OUT	Item no.
Current signal insulator	4 ... 20 mA	4 ... 20 mA	561 152

**Interconnection possibilities with other Bürkert devices**

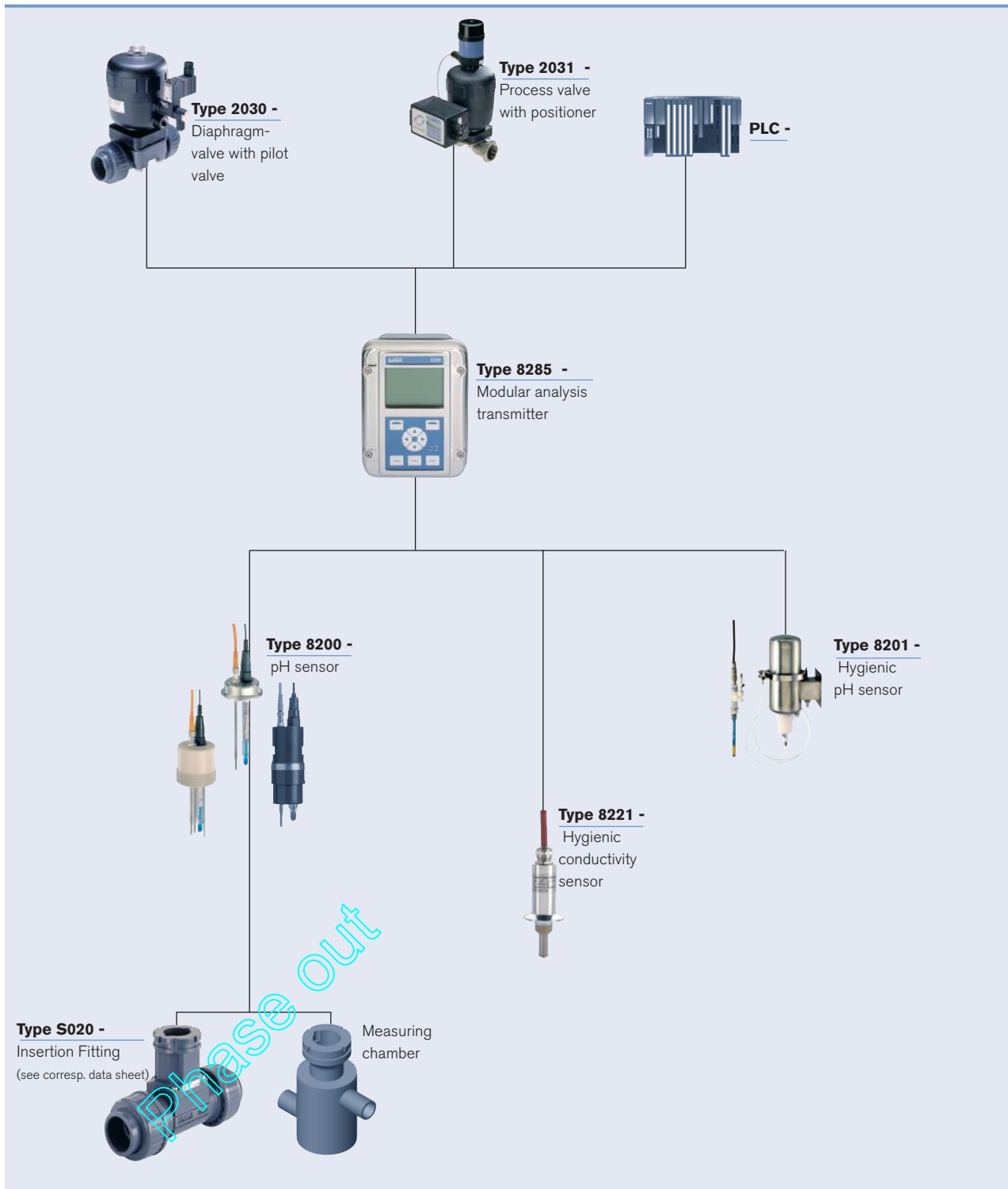

DTS 1000096130 EN Version: C Status: PO (Phase out) | Phase out | Phase out | printed: 22.09.2017

To find your nearest Bürkert facility, click on the orange box →

[www.burkert.com](http://www.burkert.com)

In case of special application conditions, please consult for advice.

Subject to alteration.  
© Christian Bürkert GmbH & Co. KG

0904/2\_EU-en\_00895021