



Chlorine sensor

- Free chlorine sensor “Trace” with three electrodes for measuring at low concentrations
- Free chlorine sensor with three electrodes and greatly reduced pH dependency
- Free chlorine sensor with two electrodes for standard applications at a constant pH value
- Total chlorine sensor with three electrodes and greatly reduced pH dependency

Product variants described in the data sheet may differ from the product presentation and description.

Can be combined with



Type 8619 ▶
multiCELL - Multi-channel and multi-function transmitter/controller



Type 8200 ▶
Armatures for analytical sensors

Type description

The 8232 from Bürkert is an electrochemical sensor for measuring the free or total chlorine content of an inorganic source (chlorine gas, sodium hypochlorite solution, ...).

Four variants of Type 8232 are available:

- The “Trace” chlorine sensor (zero chlorine) equipped with three electrodes is suitable for measuring very low concentrations of free chlorine. The diaphragm of this sensor is protected against biofouling and can therefore work for up to four weeks in water without chlorine. It has a voltage output on a 5-pin M12 circular male connector.
- The free chlorine sensor with three electrodes offers greatly reduced pH dependency. The sensor has a current output on a 5-pin M12 circular male connector and is designed for applications in swimming pool, drinking or sea water. The liquid must contain a minimum chlorine concentration (≥ 0.1 ppm).
- The free chlorine sensor with two electrodes delivers a current output on a 5-pin M12 circular male connector. This sensor is designed for use with swimming pool, drinking or process water. The fluid being measured must not contain any cleaning agents (e.g. surfactants) or abrasive particles. The pH value must be kept at a constant level. The fluid must contain a minimum chlorine concentration (≥ 0.1 ppm)
- The total chlorine sensor with three electrodes offers greatly reduced pH dependency. The sensor has a current output on a 5-pin M12 circular male connector and is suitable for applications in swimming pools, drinking or sea water, and brine.

It measures total chlorine = free chlorine + combined chlorine.

Table of contents

1. General technical data	3
2. Materials	8
2.1. Chemical Resistance Chart – Bürkert resistApp.....	8
2.2. Material specifications	8
Free chlorine sensor “Trace” (zero-chlorine) with membrane cap M48.2	8
Free chlorine sensor with 3 electrodes with membrane cap M48.4	8
Free chlorine sensor with 2 electrodes with membrane cap M20.2	9
Total chlorine sensor with 3 electrodes with membrane cap M48.4	9
3. Dimensions	10
4. Performance specifications	10
4.1. Free chlorine sensor “Trace” (zero-chlorine) with membrane cap M48.2	10
Slope versus pH	10
4.2. Free chlorine sensor with 3 electrodes with membrane cap M48.4	11
Slope versus pH	11
Slope versus flow rate	11
4.3. Free chlorine sensor with 2 electrodes with membrane cap M20.2	12
Slope versus pH	12
Slope versus flow rate	12
4.4. Total chlorine sensor with 3 electrodes with membrane cap M48.4	13
Slope versus pH	13
Slope versus flow rate	13
5. Product installation	14
5.1. Installation notes.....	14
6. Product operation	14
6.1. Measuring principle	14
7. Product design and assembly	14
7.1. Product features	14
8. Networking and combination with other Bürkert products	15
9. Ordering information	15
9.1. Bürkert eShop – Easy ordering and quick delivery.....	15
9.2. Recommendation regarding product selection	15
9.3. Bürkert product filter	15
9.4. Ordering chart.....	16
9.5. Ordering chart accessories.....	16

1. General technical data

Note:

The chlorine sensor Type 8232 is available in four models.

Sensor model	Free chlorine sensor "Trace" (zero-chlorine)	Free chlorine sensor with 3 electrodes	Free chlorine sensor with 2 electrodes	Total chlorine sensor with 3 electrodes
Product properties				
Material				
Detailed information on the materials can be found in chapter	"Free chlorine sensor "Trace" (zero-chlorine) with membrane cap M48.2" on page 8.	"Free chlorine sensor with 3 electrodes with membrane cap M48.4" on page 8.	"Free chlorine sensor with 2 electrodes with membrane cap M20.2" on page 9.	"Total chlorine sensor with 3 electrodes with membrane cap M48.4" on page 9.
Non wetted parts				
Ring	PETP	PETP	PETP	PETP
Fixed connector	PA	PA	PA	PA
Wetted parts				
Sensor armature	PVC-U	PVC-U	PVC-U	PVC-U
Electrode holder	PEEK	PEEK	PEEK	PEEK
Electrode	Stainless steel 1.4571, silver/Silver Halide, gold	Stainless steel 1.4571, silver/Silver Halide, gold	Silver/Silver Halide, gold	Stainless steel 1.4571, silver/Silver Halide, gold
Membrane	Microporous hydrophilic	Microporous hydrophilic	Semi permeable hydrophobic	Microporous hydrophilic
Seal	NBR	NBR	NBR	NBR
Other	PVC-U, stainless steel 1.4571, PEEK	PVC-U, stainless steel 1.4571	PVC-U, ABS	PVC-U, stainless steel 1.4571
Application	For monitoring absence of chlorine in reverse osmosis systems ¹⁾ (zero-chlorine)	For monitoring free chlorine at fluctuating pH in eg. drinking water	For monitoring free chlorine at constant pH in eg. swimming pool	For monitoring total chlorine at fluctuating pH in eg. swimming pool, drinking water, sea water, brine (15 % NaCl)
Compatibility	With probe holder Type 8200 variant analytical measuring chamber Detailed information can be found in the data sheet of the armatures for analytical probe, see data sheet Type 8200 ▶.			
Dimensions	Detailed information can be found in chapter "3. Dimensions" on page 10.			
Weight	Approx. 125 g			
Measuring principle	Membrane covered, amperometric potentiostatic 3-electrode system with electronic inside (completely galvanically isolated, digital internal data processing)	Membrane covered - amperometric potentiostatic 3 electrodes system with electronic inside	Membrane covered - amperometric 2 electrodes system with electronic inside	Membrane covered - amperometric potentiostatic 3 electrodes system with electronic inside
Temperature compensation	Automatic (integrated temperature sensor) Sudden temperature changes must be avoided.			
Measured quantity	Free chlorine	Free chlorine, reduced pH dependency	Free chlorine, pH-dependent	Total chlorine (= free chlorine + bound chlorine), reduced pH dependency
Electrolyte	EMST1 gel	ECS2.1 gel	ECL1	ECP1.4 gel
Measuring range	0.005...2 ppm	0.05...20 ppm	0.05...20 ppm	<ul style="list-style-type: none"> • 0.05...5 ppm • 0.05...20 ppm
Zero point adjustment	Not necessary	Not necessary	Not necessary	Not necessary

Sensor model	Free chlorine sensor "Trace" (zero-chlorine)	Free chlorine sensor with 3 electrodes	Free chlorine sensor with 2 electrodes	Total chlorine sensor with 3 electrodes
Cross sensitivity/Interference	<ul style="list-style-type: none"> • ClO₂, O₃ influence the signal strongly. • High concentrations of bound chlorine can increase the measured value. • Corrosion inhibitors, Stabilisers for water hardness can lead to measuring errors. • Reducing agents can lead to a loss in slope. 	<ul style="list-style-type: none"> • ClO₂ (factor 0.75), O₃ (factor 0.8) influence the signal. • High concentrations of bound chlorine can increase the measured value. • Corrosion inhibitors, Stabilisers for water hardness can lead to measuring errors. 	<ul style="list-style-type: none"> • ClO₂ (factor 9), O₃ influence the signal. • Electrolytically generated chlorine with a cell without membrane can disturb measurement. 	<ul style="list-style-type: none"> • ClO₂ (factor 1) • O₃ (factor 1.3) • Corrosion inhibitors, Stabilisers for water hardness can lead to measuring errors.
Maintenance²⁾				
Control of the measuring signal	Min. once a week recommended	Min. once a week recommended	Min. once a week recommended	Min. once a week recommended
Change of the membrane cap	Once a year recommended	Once a year recommended	Once a year recommended	Once a year recommended
Change of the electrolyte	Every 3...6 months recommended	Once a year recommended	Every 3...6 months recommended	Once a year recommended
Product accessories				
Membrane cap	M48.2 with intern holder (G-holder)	M48.4E (M48.4S for sea water on request)	M20.2	M48.4E (M48.4S for sea water or brine on request)
Chlorination agent	Inorganic chlorine compounds: <ul style="list-style-type: none"> • NaOCl (sodium hypochlorite) • Ca(OCl)₂ • Chlorine gas • Electrolytically generated chlorine 	Inorganic chlorine compounds: <ul style="list-style-type: none"> • NaOCl (sodium hypochlorite) • Ca(OCl)₂ • Chlorine gas • Electrolytically generated chlorine 	Inorganic chlorine compounds: <ul style="list-style-type: none"> • NaOCl (sodium hypochlorite) • Ca(OCl)₂ • Chlorine gas • Chlorine electrolysis with membrane cell (unsuitable: chlorine electrolysis without membrane cell) 	Inorganic chlorine compounds: <ul style="list-style-type: none"> • NaOCl (sodium hypochlorite) • Ca(OCl)₂ • Chlorine gas • Electrolytically generated chlorine
Suitable transmitter	Type 8619 multiCELL ▶ Transmitter/Controller ³⁾ or any transmitter with appropriate input			
Further accessory	<ul style="list-style-type: none"> • Photometer MD100 • DPD-1 reagent • External calibration device 	<ul style="list-style-type: none"> • Photometer MD100 • DPD-1 reagent 	<ul style="list-style-type: none"> • Photometer MD100 • DPD-1 reagent 	<ul style="list-style-type: none"> • Photometer MD100 • DPD-4 reagent • DPD-1 + DPD-3 reagents
Detailed information can be found in chapter "9.5. Ordering chart accessories" on page 16.				
Performance data				
Sensor resolution	0.001 ppm	0.01 ppm	0.01 ppm	0.01 ppm
Run-in time	After first start-up and maintenance operations approx. 2 hours	After first start-up and maintenance operations approx. 2 hours	After first start-up and maintenance operations approx. 1 hour	After first start-up and maintenance operations approx. 2 hours
Response time (t90 %)	Approx. 120 s	Approx. 120 s	Approx. 30 s	Approx. 3 min. (brine approx. 5 min.)
Sensor reactivity loss	After max. 4 weeks use in chlorine-free water	After max. 24 hours use in chlorine-free water	After max. 24 hours use in chlorine-free water	After max. 24 hours use in chlorine-free water

DTS 1000231931 EN Version: M Status: RL (released | freigegeben | valide) printed: 13.12.2022

Sensor model	Free chlorine sensor "Trace" (zero-chlorine)	Free chlorine sensor with 3 electrodes	Free chlorine sensor with 2 electrodes	Total chlorine sensor with 3 electrodes
Slope	-	Slope of these sensors can vary depending on production or application between 65 % and 150 % of the nominal slope. Recommendation to determinate the suitable measuring range or the suitable sensor: concentration to be measured x factor 1.5 = measuring range of the sensor Example: concentration to be measured 1.6 ppm x 1.5 = 2.4 Result: recommended sensor with a measuring range of 5 ppm		
Calibration	<ul style="list-style-type: none"> Generate a stable chlorine concentration in the measuring water, use DPD-1 method If no chlorine in the measuring water is allowed, use an external calibration equipment and the DPD-1 method. Detailed information can be found in chapter "9.5. Ordering chart accessories" on page 16 	By the analytical determination DPD-1 method (Reference value)	By the analytical determination DPD-1 method (Reference value)	By analytical determination, DPD-4-or (DPD-1 + DPD-3) methods
Drift	Approx. -3 % per month, in reference conditions (25 °C, pH 7.2 in drinking water)	Approx. -1 % per month, in reference conditions (25 °C, pH 7.2 in drinking water)	Approx. -1 % per month, in reference conditions (25 °C, pH 7.2 in drinking water)	Approx. -1 % per month, in reference conditions (25 °C, pH 7.2 in drinking water)
Electrical data				
Operating voltage	<ul style="list-style-type: none"> 9...30 V DC, filtered and regulated (otherwise the probe may be damaged) The power supply is galvanically isolated inside of the sensor. 	<ul style="list-style-type: none"> 12...30 V DC, filtered and regulated, R_L: 50...900 Ω (e.g. through the 8619 multiCELL Transmitter/Controller) Not galvanically isolated inside of the sensor 	<ul style="list-style-type: none"> 12...30 V DC, filtered and regulated, R_L: 50...900 Ω (e.g. through the 8619 multiCELL Transmitter/Controller) Not galvanically isolated inside of the sensor 	<ul style="list-style-type: none"> 12...30 V DC, filtered and regulated, R_L: 50...900 Ω (e.g. through the 8619 multiCELL Transmitter/Controller) Not galvanically isolated inside of the sensor
Current consumption	Approx. 56...20 mA	Approx. 4 mA (max. current by overloading: 30 mA)	Approx. 4 mA (max. current by overloading: 30 mA)	Approx. 4 mA (max. current by overloading: 30 mA)

DTS 1000231931 EN Version: M Status: RL (released | freigegeben | valide) printed: 13.12.2022

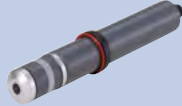
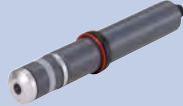
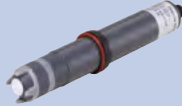
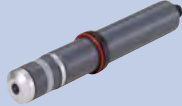
Sensor model	Free chlorine sensor "Trace" (zero-chlorine)	Free chlorine sensor with 3 electrodes	Free chlorine sensor with 2 electrodes	Total chlorine sensor with 3 electrodes
				
Output	Voltage (4-wire): <ul style="list-style-type: none"> Analog signal 0...2000 mV (max. 2500 mV) Galvanically insulated, that means potential-free Output resistance: 1 kΩ 	Current (2-wire): <ul style="list-style-type: none"> Analog signal 4...20 mA (uncalibrated, at pH 7.2 nominal slope 0.8 mA/ppm) Not galvanically insulated⁴⁾ Max. loop impedance (valid with Type 8619 multiCELL³⁾): 50 Ω at 12 V DC, 900 Ω at 30 V DC 	Current (2-wire): <ul style="list-style-type: none"> Analog signal 4...20 mA (uncalibrated, at pH 7.2 nominal slope 0.8 mA/ppm) Not galvanically insulated⁴⁾ Max. loop impedance (valid with Type 8619 multiCELL³⁾): 50 Ω at 12 V DC, 900 Ω at 30 V DC 	Current (2-wire): <ul style="list-style-type: none"> Analog signal 4...20 mA (uncalibrated, at pH 7.2 nominal slope 3.2 mA/ppm for variant 0.05...5 ppm or 0.8 mA/ppm for variant 0.05...20 ppm) Not galvanically insulated⁴⁾ Max. loop impedance (valid with Type 8619 multiCELL³⁾): 50 Ω at 12 V DC, 900 Ω at 30 V DC
Medium data				
Fluid	Water with similar characteristics to drinking water	<ul style="list-style-type: none"> Drinking water, swimming pool water, sea water Surfactants are partially tolerated 	<ul style="list-style-type: none"> Swimming pool water, drinking water, service water, process water Free of any surfactants With constant pH value 	<ul style="list-style-type: none"> Drinking water, swimming pool water, sea water, brine (15% NaCl) Surfactants are partially tolerated
Fluid flow rate	15...30 l/h mounted in analytical measurement chamber 8200, the measuring value depends on the flow rate (ensure constant flow rate)	15...30 l/h mounted in analytical measurement chamber 8200, the measuring value depends on the flow rate (ensure constant flow rate) Detailed information can be found in chapter "Slope versus flow rate" on page 11.	15...30 l/h mounted in analytical measurement chamber 8200, the measuring value depends on the flow rate (ensure constant flow rate) Detailed information can be found in chapter "Slope versus flow rate" on page 12.	15...30 l/h mounted in analytical measurement chamber 8200, the measuring value depends on the flow rate (ensure constant flow rate) Detailed information can be found in chapter "Slope versus flow rate" on page 13.
Fluid pH range	pH 6.5...pH 9 Detailed information can be found in chapter "Slope versus pH" on page 10.	pH 4...pH 9 Detailed information can be found in chapter "Slope versus pH" on page 11.	pH 6...pH 8 (attention to the dissociation equilibrium HOCl, pH has to be constant) Detailed information can be found in chapter "Slope versus pH" on page 12.	pH 4...pH 12, reduced dependence on pH value Detailed information can be found in chapter "Slope versus pH" on page 13.
Fluid conductivity	–	10 μ S/cm...50 mS/cm (sea water)	–	10 μ S/cm...200 mS/cm (brine water)
Fluid temperature	0...+40 °C (+32...+104 °F)	0...+45 °C (+32...+113 °F)	0...+45 °C (+32...+113 °F)	0...+45 °C (+32...+113 °F)
No ice crystals in the measuring water. If the temperature ranges given for the holder and the used sensor are different, use the most restrictive range.				

Sensor model	Free chlorine sensor "Trace" (zero-chlorine)	Free chlorine sensor with 3 electrodes	Free chlorine sensor with 2 electrodes	Total chlorine sensor with 3 electrodes

Fluid pressure	Max. 0.5 bar (7.26 PSI), operation with or without retaining ring, no pressure drops and/or vibrations	<ul style="list-style-type: none"> Max. 3.0 bar (43.53 PSI), operation with retaining ring, no pressure drops and/or vibrations Max. 0.5 bar (7.26 PSI), operation without retaining ring, no pressure drops and/or vibrations 	<ul style="list-style-type: none"> Max. 1 bar (14.5 PSI), operation with retaining ring, no pressure drops and/or vibrations Max. 0.5 bar (7.26 PSI), operation without retaining ring, no pressure drops and/or vibrations 	<ul style="list-style-type: none"> Max. 3.0 bar (43.53 PSI), operation with retaining ring, no pressure drops and/or vibrations Max. 0.5 bar (7.26 PSI), operation without retaining ring, no pressure drops and/or vibrations
----------------	--	--	---	--

If the pressure ranges given for the holder and the used sensor are different, use the most restrictive range. Pressure drops are not allowed; the membrane could be damaged

Process/Pipe connection & communication

Process connection	With probe holder Type 8200, see data sheet Type 8200 ▶.			
Electrical connection	5-pin M12 circular male connector	5-pin M12 circular male connector	5-pin M12 circular male connector	5-pin M12 circular male connector

Approvals and certificates

Directives

CE directive The applied standards, which verify conformity with the EU Directives, can be found on the EU Type Examination Certificate and/or the EU Declaration of conformity (if applicable).

Environment and installation

Ambient temperature

Operation	0...+55 °C (+32...+131 °F)			
Storage	<ul style="list-style-type: none"> Probe: unlimited time at +5...+40 °C (+41...+104 °F), frost protected, dry and without electrolyte Membrane cap: <ul style="list-style-type: none"> in original packing unlimited time at +5...+40 °C (+41...+104 °F) used membrane caps cannot be stored Electrolyte: +5...+35 °C (+41...+95 °F), 1 year or until the specified expiry date in original bottle protected from sunlight 			
Transport	+5...+50 °C (+41...+122 °F)	+5...+55 °C (+41...+131 °F)	+5...+50 °C (+41...+122 °F)	+5...+50 °C (+41...+122 °F)
Relative air humidity	≤90 %, without condensation			
Height above sea level	Max. 2000 m			
Degree of protection according to IEC/EN 60529	IP65 with cable plug mounted and tightened			

1.) Avoids fouling effects on the membrane in water without any chlorine for up to four weeks.

2.) Depends strongly on the water quality; values are recommendations for drinking water quality.

3.) Analogue input board necessary. Software variant of input board must be A.03.00 or higher; otherwise contact your local Bürkert support.

4.) A potential-free electrical connection is necessary as the chlorine sensor is not equipped with a galvanic isolation.

2. Materials

2.1. Chemical Resistance Chart – Bürkert resistApp

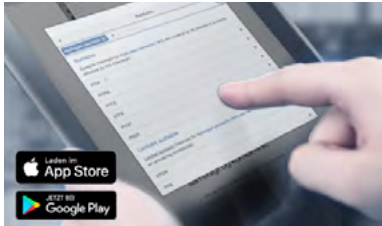

Bürkert resistApp – Chemical Resistance Chart

You want to ensure the reliability and durability of the materials in your individual application case? Verify your combination of media and materials on our website or in our resistApp.

[Start Chemical Resistance Check](#)

2.2. Material specifications

Free chlorine sensor “Trace” (zero-chlorine) with membrane cap M48.2

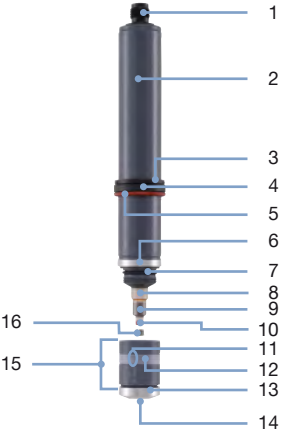

No.	Element	Material
1	5-pin M12 circular male connector	PA
2	Sensor armature	PVC-U
3	Retaining ring	PETP
4	Slide ring	PETP
5	Sealing (O-ring)	NBR
6	Counter electrode	Stainless steel 1.4571
7	Sealing (O-ring)	NBR
8	Electrode holder	PEEK
9	Reference electrode	Silver/Silver Halide
10	Working electrode	Gold
11	Vent (under hose ring)	Stainless steel 1.4571
12	Hose ring	–
13	Membrane holder	Stainless steel 1.4571, PEEK
14	Membrane	Microporous hydrophilic
15	Membrane cap	PVC-U
16	Intern holder (G-holder)	–

Free chlorine sensor with 3 electrodes with membrane cap M48.4



No.	Element	Material
1	5-pin M12 circular male connector	PA
2	Sensor armature	PVC-U
3	Retaining ring	PETP
4	Slide ring	PETP
5	Sealing (O-ring)	NBR
6	Counter electrode	Stainless steel 1.4571
7	Sealing (O-ring)	NBR
8	Electrode holder	PEEK
9	Reference electrode	Silver/Silver Halide
10	Working electrode	Gold
11	Vent (under hose ring)	–
12	Hose ring	–
13	Membrane holder	<ul style="list-style-type: none"> Stainless steel 1.4571 for membrane cap M48.4E PEEK for membrane cap M48.4S (sea water quality)
14	Membrane	Microporous hydrophilic
15	Membrane cap	PVC-U

Free chlorine sensor with 2 electrodes with membrane cap M20.2

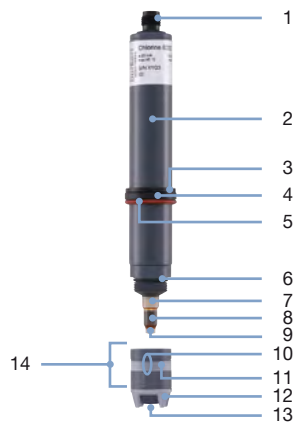

No.	Element	Material
1	5-pin M12 circular male connector	PA
2	Sensor armature	PVC-U
3	Retaining ring	PETP
4	Slide ring	PETP
5	Sealing (O-ring)	NBR
6	Sealing (O-ring)	NBR
7	Electrode holder	PEEK
8	Reference electrode	Silver/Silver Halide
9	Working electrode	Gold
10	Vent (under hose ring)	-
11	Hose ring	-
12	Membrane protection	ABS
13	Membrane	Semi permeable hydrophobic
14	Membrane cap	PVC-U

Total chlorine sensor with 3 electrodes with membrane cap M48.4

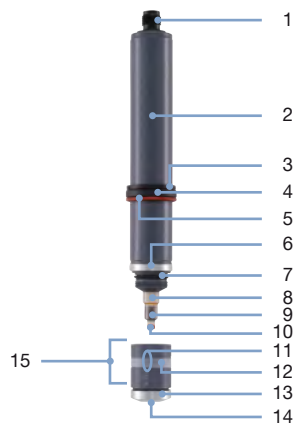

No.	Element	Material
1	5-pin M12 circular male connector	PA
2	Sensor armature	PVC-U
3	Retaining ring	PETP
4	Slide ring	PETP
5	Sealing (O-ring)	NBR
6	Counter electrode	Stainless steel 1.4571
7	Sealing (O-ring)	NBR
8	Electrode holder	PEEK
9	Reference electrode	Silver/Silver Halide
10	Working electrode	Gold
11	Vent (under hose ring)	-
12	Hose ring	-
13	Membrane holder	<ul style="list-style-type: none"> Stainless steel 1.4571 for standard membrane cap M48.4E PEEK for membrane cap M48.4S (sea water quality)
14	Membrane	Microporous hydrophilic
15	Membrane cap	PVC-U

3. Dimensions

Note:

Dimensions in mm, unless otherwise stated

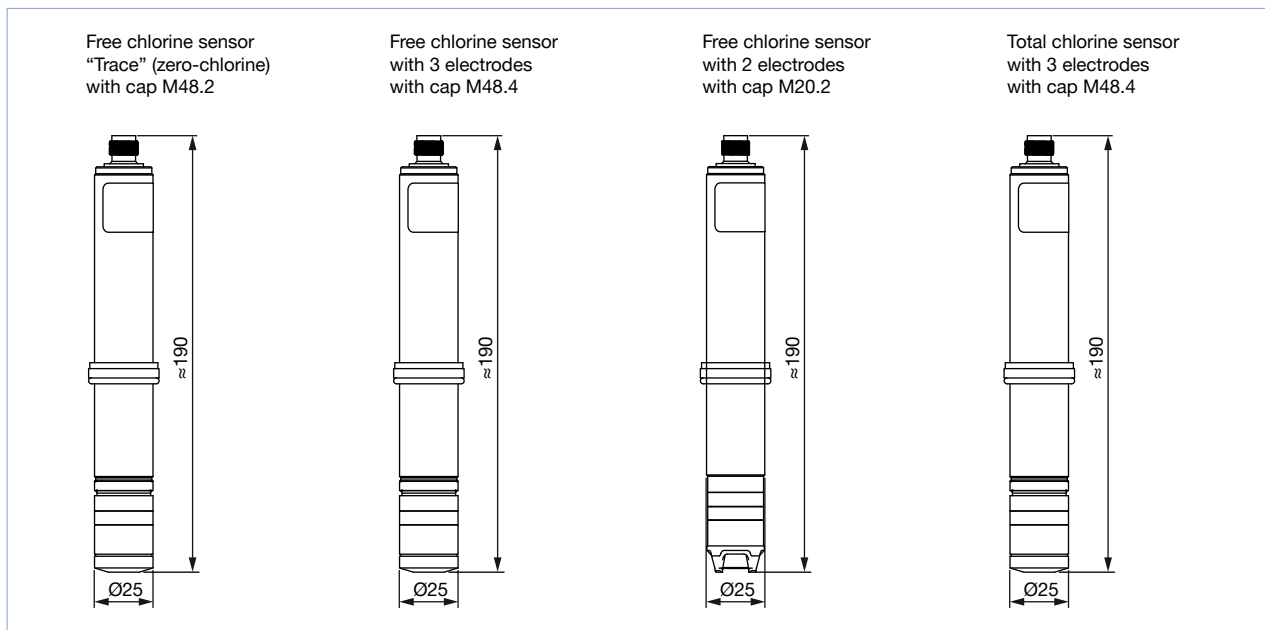

4. Performance specifications

4.1. Free chlorine sensor "Trace" (zero-chlorine) with membrane cap M48.2

Slope versus pH

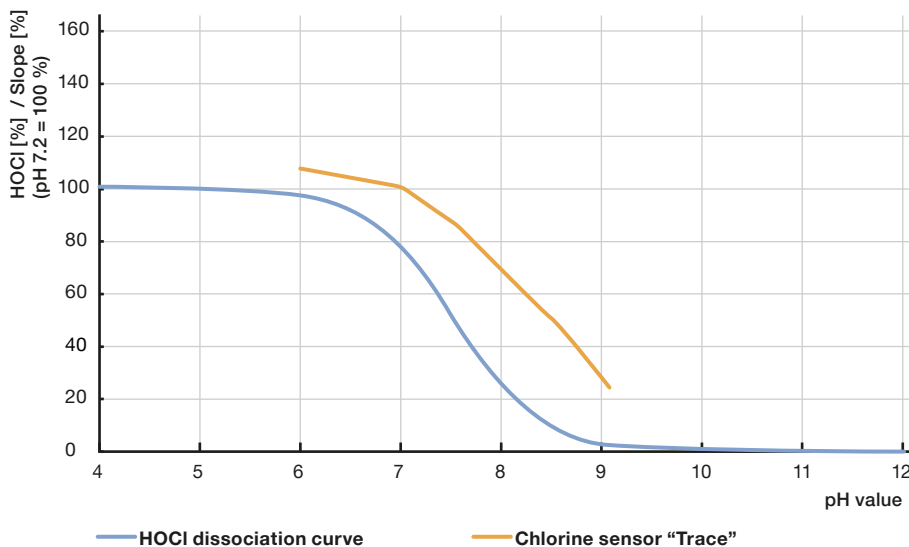

Temperature: 25 °C / Flow rate: 30 l/h

pH regulation:
 pH decrease: H₂SO₄
 pH increase: NaOH

DTS 1000231931 EN Version: M Status: RL (released | freigegeben | validé) printed: 13.12.2022

4.2. Free chlorine sensor with 3 electrodes with membrane cap M48.4

Slope versus pH

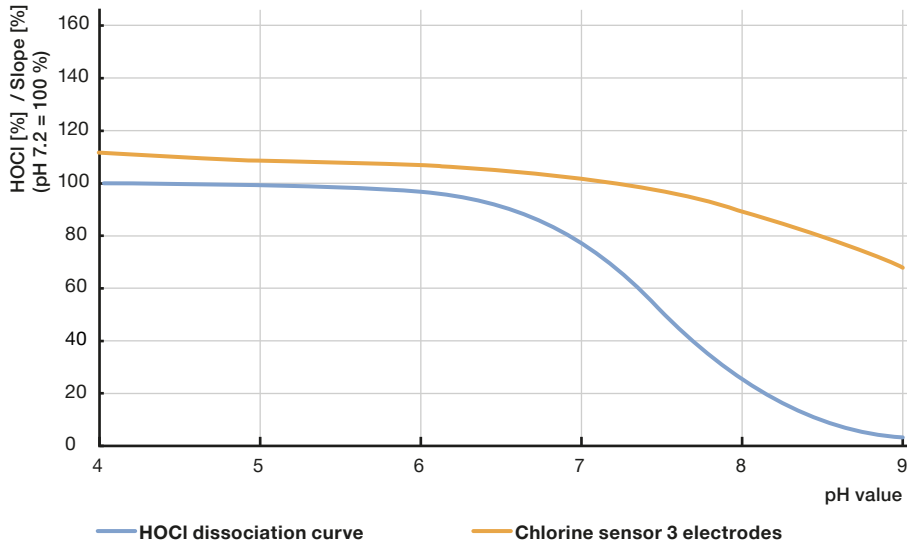

Temperature: 25 °C / Flow rate: 30 l/h

pH regulation:
 pH decriaser: H₂SO₄
 pH increaser: NaOH

Slope versus flow rate

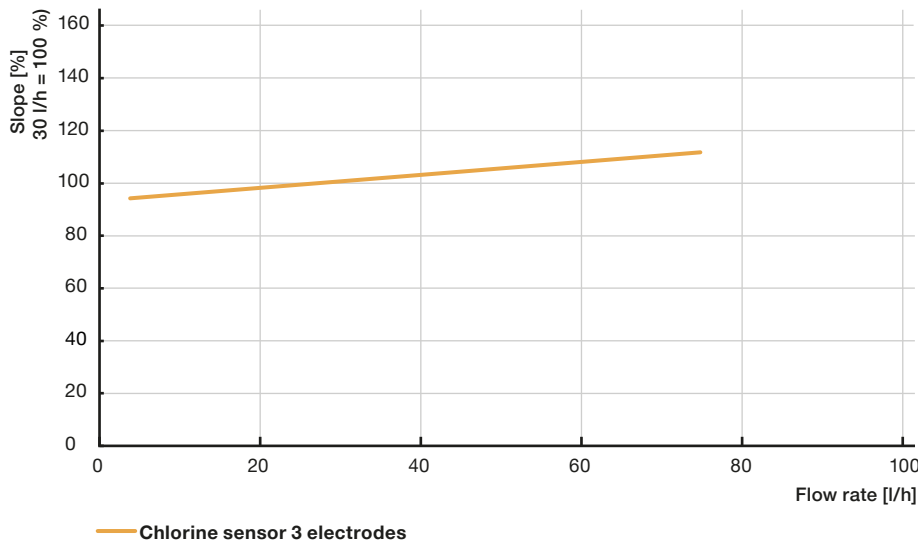

Temperature: 25 °C / pH value: 7.2

This values are only valid for
 the measuring chamber Type 8200

4.3. Free chlorine sensor with 2 electrodes with membrane cap M20.2

Slope versus pH

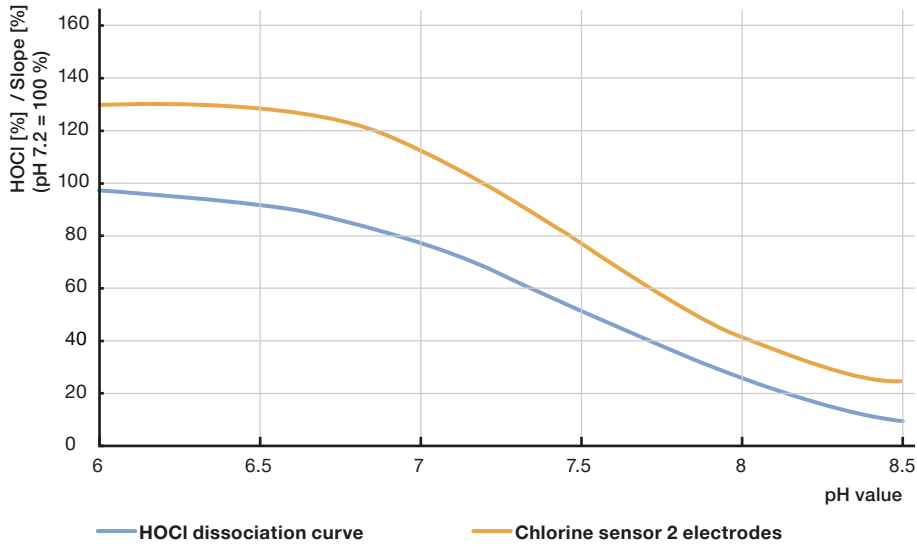

Slope versus flow rate

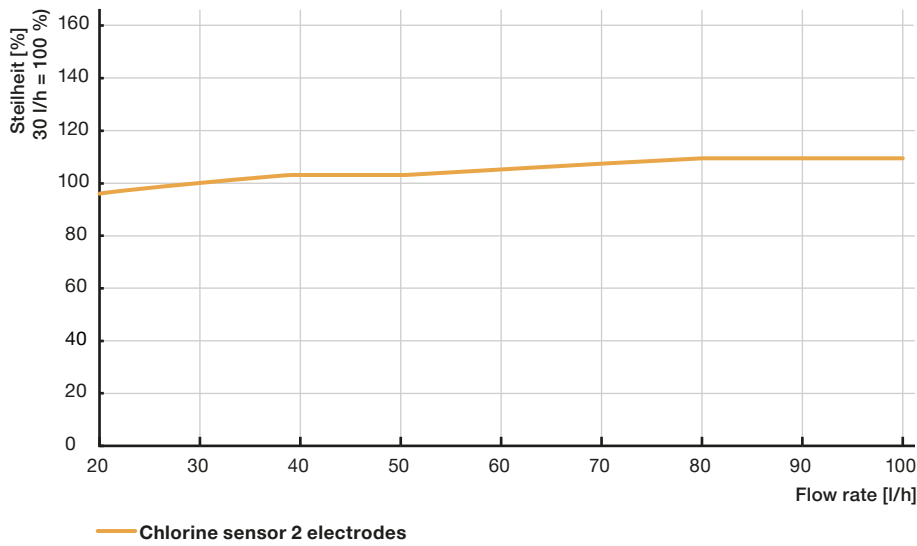

4.4. Total chlorine sensor with 3 electrodes with membrane cap M48.4

Slope versus pH

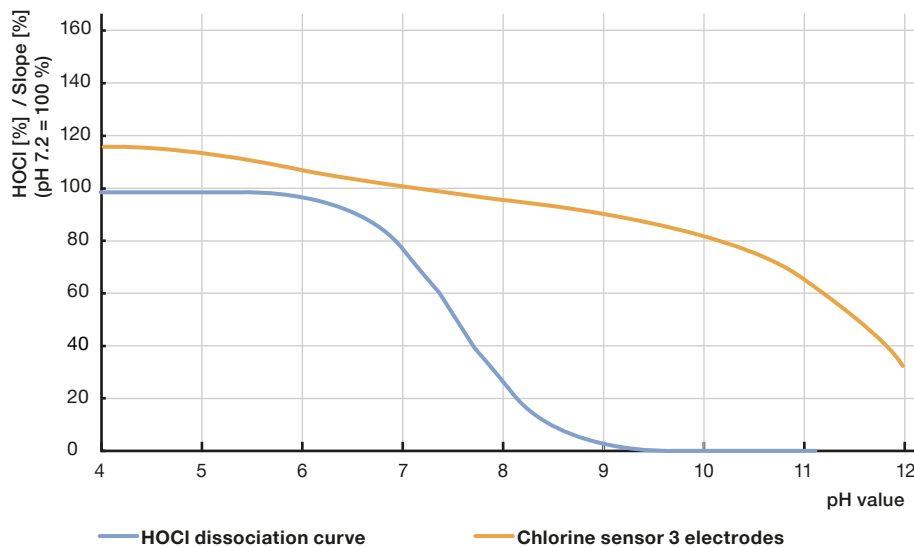

Temperature: 25 °C / Flow rate: 30 l/h

pH regulation:
 pH decrease: H₂SO₄
 pH increase: NaOH

Slope versus flow rate

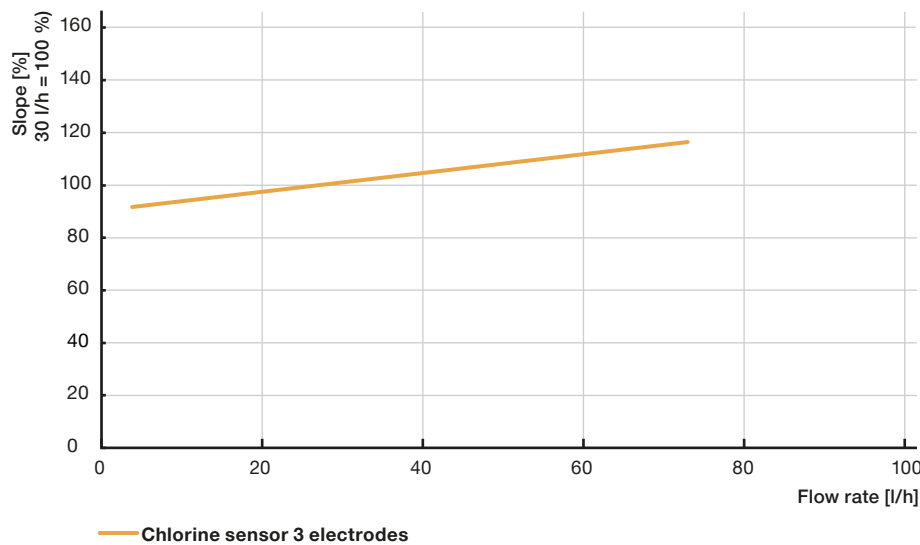

Temperature: 25 °C / pH value: 7.2

This values are only valid for the measuring chamber Type 8200

DTS 1000231931 EN Version: M Status: RL (released | freigegeben | validé) printed: 13.12.2022

5. Product installation

5.1. Installation notes

Measuring chamber	Description
	<p>The requirements for maintaining and monitoring a constant flow rate of the analysed water, necessitate the use of an appropriate measuring chamber. Thus the sensor Type 8232 has to be installed in the analytical measuring chamber Type 8200. Otherwise the liability for a proper function of the sensor will be declined.</p> <p>See data sheet Type 8200 ▶ for more information.</p> <p>This analytical measurement chamber has to be installed so that the inserted chlorine sensor is in an upright position, and so that the incoming flow rate comes from the bottom up to the membrane. Gas bubbles at the membrane leads to incorrect measuring signals. For continuous flow monitoring, an inductive flow switch is available optionally, to be mounted in the analytical measurement chamber Type 8200.</p> <p>Do not install the sensor in the main pipe. Measure only in bypass with use of the analytical measuring chamber Type 8200.</p>

6. Product operation

6.1. Measuring principle

Depending on the variant, the 8232 Sensor measures either the free chlorine or the total chlorine content. Total chlorine is the sum of free chlorine (disinfectant chlorine) and bound chlorine (Concentration of chlorine combined with organic and inorganic nitrogen compounds present in the water).

The chlorine sensor is a two or three-electrode measuring system (depends on variant) covered with a membrane. The membrane cap filled with a special electrolyte, protects the working and reference electrodes from direct contact with the measuring water. With this measuring method, ionic substances in the water are held back by the membrane, whereas the substance to be determined (disinfectant or chlorine) can pass through the membrane without restriction. The diffusion of the substance through the membrane ensures that the concentrations on both sides of the membrane are equal and causes an electrical signal on the working electrode. The 2-electrode measuring system consists of a working electrode and a reference electrode, between which a certain voltage (polarization voltage) is applied. The 3-electrode measuring system consists of a working electrode, a reference electrode and a counter electrode. The measuring signal at the working electrode is proportional to the concentration of the disinfectant or to the chlorine concentration and is amplified by the electronics of the sensor. The measuring signal is independent from the temperature of the measuring water due to an integrated temperature compensation.

The calibration must be done on a transmitter/controller with a reference value. The transmitter Type 8619 multiCELL is suited and recommended, but any other suited transmitter can be also used.

See [data sheet Type 8619](#) ▶ for more information.

7. Product design and assembly

7.1. Product features

Note:

The following table gives an overview of the features for sensor selection.

Feature details	Free chlorine sensor			Total chlorine sensor
	“Trace” (zero-chlorine)	with 3 electrodes	with 2 electrodes	with 3 electrodes
Works in water without chlorine for up to 4 weeks	Yes	No	No	No
Galvanically isolated	Yes	No	No	No
Greatly reduced pH dependency	Yes ^{1.)}	Yes	No	Yes
Surfactants are partially tolerated	Yes	Yes	No	Yes
Temperature compensation	Yes	Yes	Yes	Yes
Zero-Point stability	Yes	Yes	Yes	Yes
Membrane covered	Yes	Yes	Yes	Yes
Two-wire device	No	Yes	Yes	Yes

1.) Chlorine sensor “Trace” has a higher pH dependency compared to the chlorine sensor with 3 electrodes.

8. Networking and combination with other Bürkert products

Example:

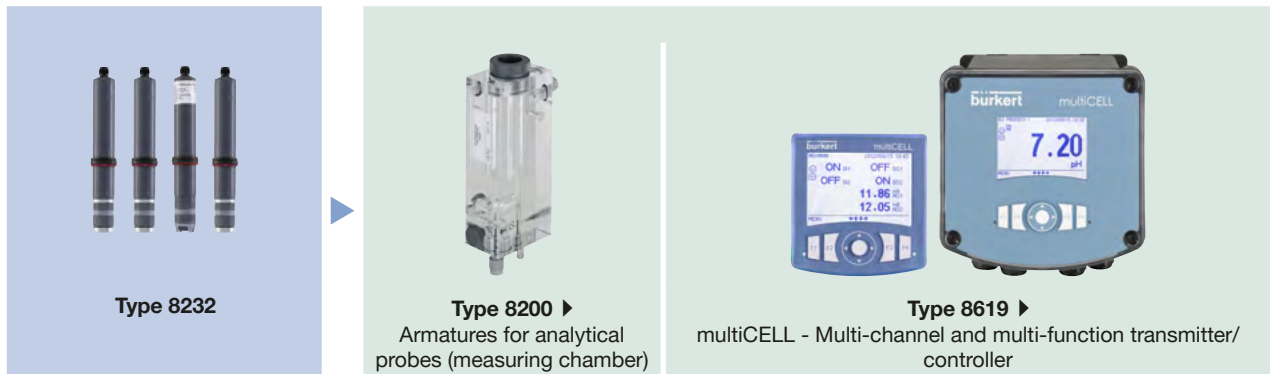

9. Ordering information

9.1. Bürkert eShop – Easy ordering and quick delivery



Bürkert eShop – Easy ordering and fast delivery

You want to find your desired Bürkert product or spare part quickly and order directly? Our online shop is available for you 24/7. Sign up and enjoy all the benefits.

[Order online now](#)

9.2. Recommendation regarding product selection

A complete chlorine measuring system consists of a chlorine sensor Type 8232, a circular female connector with cable, an analytical measurement chamber Type 8200, an electrolyte (the delivery includes one electrolyte bottle) and the multiCELL controller Type 8619 (analogue input board necessary. Software version of input board must be the version A.03.00 or higher; otherwise contact your local Bürkert support).

Three or four different components must be ordered in order to select a complete device. The following information is required:

- **Article no.** of the analytical measurement chamber **Type 8200** (see chapter “9.5. Ordering chart accessories” on page 16 or [data sheet Type 8200](#) ▶)
- **Article no.** of the desired chlorine sensor **Type 8232** (see chapter “9.4. Ordering chart” on page 16)
- **Article no.** of the circular female connector (see chapter “9.5. Ordering chart accessories” on page 16)
- **Article no.** of the multiCELL transmitter/controller **Type 8619** (see [data sheet Type 8619](#) ▶)

9.3. Bürkert product filter



Bürkert product filter – Get quickly to the right product

You want to select products comfortably based on your technical requirements? Use the Bürkert product filter and find suitable articles for your application quickly and easily.

[Try out our product filter](#)

9.4. Ordering chart

Sensor variant		Description	Measuring range	Output	Electrical connection	Article no.
			[ppm]			
	"Trace" (zero-chlorine) with 3 electrodes	Measures at very low chlorine concentrations	0.005...2	0...2000 mV (max. 2500 mV)	5-pin M12 circular male connector	572928
	With 3 electrodes	Measures the concentration of free chlorine with greatly reduced pH dependency	0.05...20	4...20 mA		568523
	With 2 electrodes	Measures the concentration of free chlorine	0.05...20			568524
	With 3 electrodes	Measures the concentration of total chlorine with greatly reduced pH dependency	0.05...5			569698
	With 3 electrodes	Measures the concentration of total chlorine with greatly reduced pH dependency	0.05...20			573799

Further versions on request

	Additional Measurement parameter (chlorine dioxide, or others)		Electrical connection Screw terminal
--	--	--	--

9.5. Ordering chart accessories

Description	Article no.
Analytical measurement chamber Type 8200	569221
Flow switch for analytical measurement chamber, PNP, 2 m cable (optional)	775261
Photometer MD100, measuring range 0.01...6 ppm	566393
DPD-1 reagent (100 Tablets)	566394
For free chlorine sensor "Trace" (zero-chlorine) with 3 electrodes (Article no. 572928)	
Electrolyte EMST1 gel, 100 ml	566060
Membrane cap M48.2 with intern holder (G-holder)	566057
5-pin M12 straight circular female connector moulded on cable (2 m, shielded)	438680
External calibration device (only needed if measuring water containing no chlorine)	565163
For free chlorine sensor with 3 electrodes (Article no. 568523)	
Electrolyte ECS2.1 gel, 100 ml	566059
Membrane cap M48.4E for standard water quality	568557
Membrane cap M48.4S for sea water quality	568558
5-pin M12 straight circular female connector moulded on cable (2 m, shielded)	438680
For free chlorine sensor with 2 electrodes (Article no. 568524)	
Electrolyte ECL1, 100 ml	566058
Membrane cap M20.2	566056
5-pin M12 straight circular female connector moulded on cable (2 m, shielded)	438680
For total chlorine sensor with 3 electrodes (Article no. 569698 and 573799)	
Electrolyte ECP1.4 gel, 100 ml	569510
Membrane cap M48.4E for standard water quality	568557
Membrane cap M48.4S for sea water quality	568558
5-pin M12 straight circular female connector moulded on cable (2 m, shielded)	438680

Bürkert – Close to You

For up-to-date addresses
please visit us at
www.burkert.com

DTS 1000231931 EN Version: M Status: RL (released | freigegeben | validé) printed: 13.12.2022

