

Type 8201 can be combined with...



Type 8619
multiCELL

Transmitter/Controller

pH measuring system for hygienic applications

- Special glass-free probe for measuring pH to be connected to Type 8619 multiCELL
- Sterile design, CIP-compatible, in-line sterilisable
- Robust and unbreakable construction
- Long service life, long calibration intervals
- Especially suitable when preparing foods and drinks

The type 8201 pH measuring system is suitable for measuring absolute pH values in liquids between pH 0 and pH 12 at medium temperatures of up to 140 °C and process pressures of max. 6 bar. Due to its hygienic design and the robust glass-free construction, this model is particularly suitable for use in hygienic processes. An example would be the production of foods and active ingredients, during which the pH value of liquid mediums - including those which are viscous or contain solids - is measured. The pH electrode's extremely smooth enamel surface inhibits the medium from sticking and is very easy to clean in line. Due to its robust design and high temperature and chemical tolerance, the electrode stays in the process even during a CIP purification. This means that expensive retractable fittings can be dispensed with.

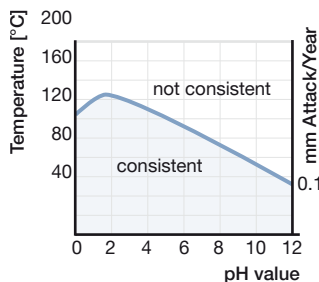

Technical data - Probe	
Measuring value	Absolute pH
Reference system	Machined diaphragm (ceramic enamelled) reference electrode Ag/AgCl, KCl electrolyte 3-molar sterile (conform to FDA)
Measuring range	0...10 pH (for up to 12 pH see diagram)
Measuring error	Depending on calibration max. 0.1 pH
Repeatability	0.05 pH
Measuring chain zero point	8.65 ±1 pH*
Measuring chain isotherm point	1.0 ±1 pH; U _{is} = 440 mV*
Slope	56...59 mV/pH* at 25 °C (77 °F)
Ambient temperature	0...+50 °C (+32...+122 °F)
Medium temperature	0...+140 °C (+32...+284 °F)
Minimal conductivity	1 µS
Thermoshock resistance	ΔT = 120 °C (248 °F)
Medium pressure	-1...+6 bar rel. (-14...+87 PSI)
Temperature compensation	Pt1000
Materials Wetted part	Probe head PVDF Enamelled steel pipe, ceramic enamelled ground diaphragm, 1.4404 process connection and EPDM seal
Signal outputs	Pt1000 2-wire, pH value in mV
Electrical connection	6 pin gold-plated
Protection rating according to IEC/EN 60529	IP68
Certificates	ECR1935/2004 declaration
Adaptation set	For pH armatures Type 8200 or Type 8201 For flange connection adapted for GEA Tuchenhagen VARINLINE process connection (DN50...DN125) or for Clamp 2*
Suitable transmitters	Type 8619 multiCELL transmitter/controller; devices with isotherm option

Hygienic connection fittings Type 8201	
	Weld connection DN25 (Ingold welding nozzle), Weld connection DN30, other on request Stainless steel connecting pieces 1.4404
pH armature Type 8200	
	Only stainless steel versions possible. For dimensions see data sheet Type 8200

* For exact values see probe test report.

Measuring principle



The pH sensor works as a single-rod measuring cell. The measuring electrode and reference electrode are combined in one element. An enamelled steel pipe is used as the basic carrier. The measuring electrode is created by additionally attaching an ion-sensitive enamel layer (yellow) with metallic voltage conductor (positioned in the non-conductive blue enamel carrier layer). An ion exchange of H⁺ ions and alkali ions takes place on the surface (gel layer) of this enamel layer. The Ag/AgCl reference electrode is located in the interior of the enamel pipe filled with electrolyte. A ceramic machined diaphragm is pressed into the lower end of the pipe. Voltage transfer takes place when the electrolyte makes contact with the measuring solution via the annular gap of the diaphragm. A Pt1000 for temperature compensation is also integrated in the sensor. The electrolyte (conform to FDA) used is 3-molar KCl, stored in a separate electrolyte vessel and permanently connected to the probe via a hose.

The pressure of the electrolyte vessel is maintained slightly above process pressure by means of an attached pressure controller. For non-pressurised processes the static overpressure of the pressure vessel mounted approx. 0.5 m above the probe is generally sufficient. Due to the very slight permanent electrolyte flow that flows through the extremely small annular gap, contamination of the reference electrode is practically eliminated. Accidental operation without electrolyte is prevented by optional inductive level monitoring of the pressure container. When a minimum level has been reached, the electrolyte supply bottle in the pressure container is simply changed.

Bürkert Transmitter/Controller Type 8619 provides the analysis of the measured value. The maximum length of cable (5 m) between probe and converter (transmitter) has to be respected. pH probe Type 8201 is supplied without adaptation. The appropriate set is selected according to the fitting/armature chosen. Different hygienic variations of Type 8201 are available. Various standard armatures Type 8200 can be used as well.

Structure

The complete measuring system consists of the pH probe, an adaptation set, an attachment fitting, the reservoir with hose for the electrolyte solution, the electrolyte solution and the electric cable for connecting to a suitable transmitter.

The pH probe Type 8201 is supplied without adaptation. According to the chosen fitting/armature the appropriate adaptation set has to be selected. Different hygienic fittings (Type 8201) or for general purpose applications pH armatures of Type 8200 can be selected.

Installation

Intended performance is limited to proper installation of the fitting (by weld), integrating the probe into the process using the appropriate adaptation kit, proper mounting of the electrolyte vessel – electrolyte attachment perpendicularly downwards – close to the measuring point and connecting the pH sensor and electrolyte vessel using the hose connection supplied. The electrolyte supply bottle is inserted into the electrolyte vessel and the pH sensor filled with electrolyte by opening the ventilation screw.

You are free to choose the assembly position of the pH sensor. During operation care must be taken that the active surface (length approx. 45 mm from probes lower edge) is completely surrounded by medium. The flow velocity should not exceed 3...4 m/s. Dry-storage of the pH sensor is unrestricted.

The probe is connected to the transmitter by means of the attachment cable. Inductive level switch is attached to a suitable analysing device.

Dimensions [mm]

pH probe enamel
 without adaptation

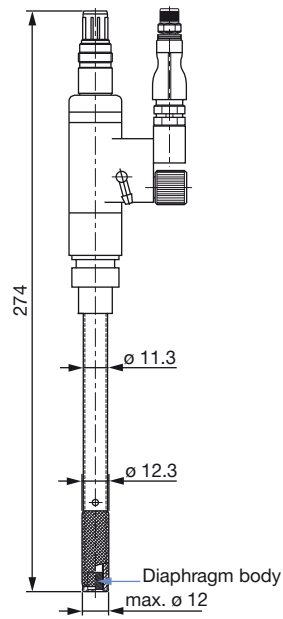

pH probe
 with adaptation set PG 13.5 for pH armature Type 8200

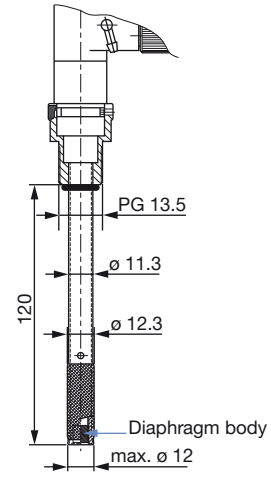

Electrolyte vessel
 with built-in electrolyte supply bottle

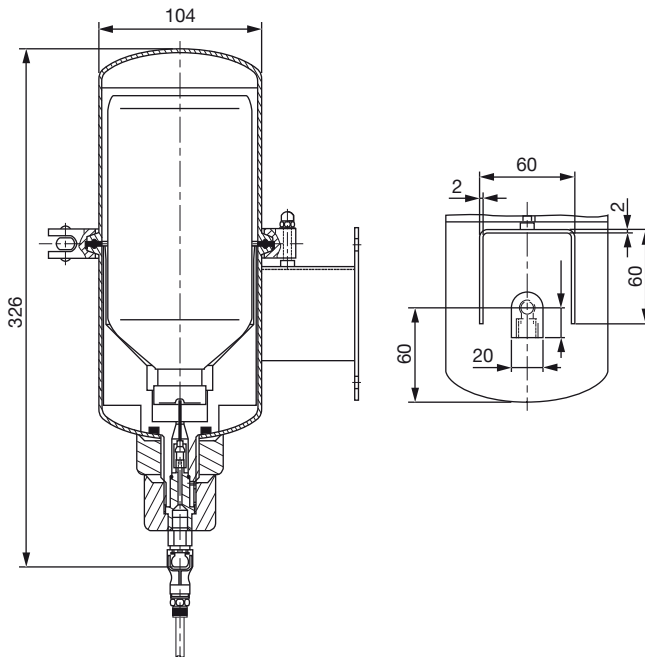

Ultrasonic level switch
 with M12 connector

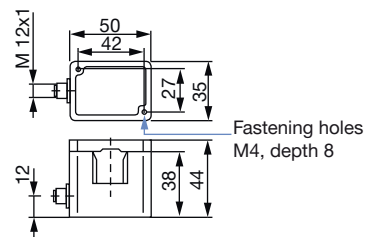

8201 pH measuring system



Dimensions [mm] (continued)

pH probe

with adaptation set for flange connection adapted for GEA Tuchenhagen VARINLINE process connection (DN50...DN125)

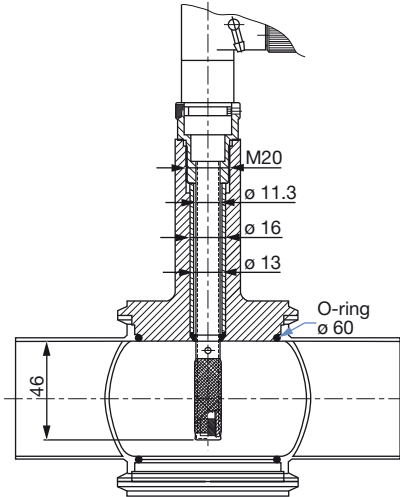

with adaptation set Clamp 2" external ϕ 64 mm

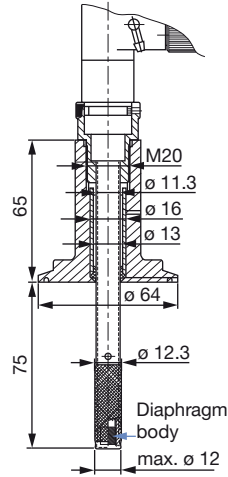

with adaptation set DN30

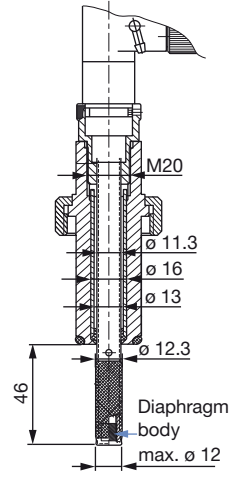

with adaptation set DN25

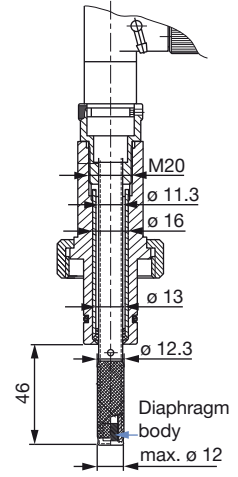

Note:

Housing and O-ring ϕ 60 not included in delivery

Fittings Type 8201

Welding tab DN30

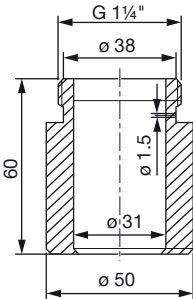

Welding tab DN25 sloped

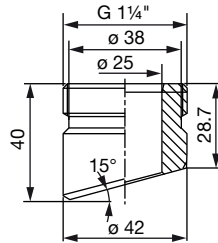

Welding tab DN25 straight

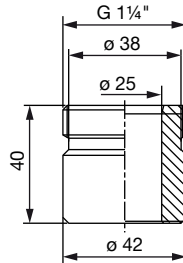

Blind plug for welding tab DN30

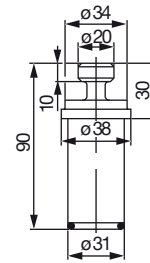

Nut for blind plug (welding tab DN30)

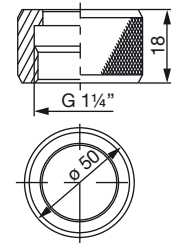

Ordering information and chart

A complete Type 8201 pH measuring system contains the following components:

- pH probe enamel
- Suitable adaptation set for fitting/armature
- Fitting/armature
- Electrolyte vessel (electrolyte hose included)
- Supply bottle with 1 litre electrolyte KCl
- Connection cable for transmitter
- Transmitter / Controller Type 8619 (see data sheet Type 8619)

Note: The cable between probe and transmitter must categorically be selected as short as possible – particularly at low process temperatures – in order to guarantee measurement signal dynamics that are as high as possible. A cable length of 10 m should only be used in exceptional cases.

If required, to disinfect and rinse the system you will need:

- Demineralized water
- Plastic bottle with septum for alcohol filling

All necessary parts have to be ordered separately

Description	pH measuring range	Medium temp.	Pressure (rel.)	Electrical connection	Article no.
Probe					
pH probe-enamel without adaptation	0...10 (12)	0...+140 °C	-1...6 bar	6 pin gold-plated	554849





Description	Comment	Article no.
Adaptation sets		
Adaptation set for welding tab DN25 Type 8201	Union nut G 1¼" / DN25	554866
Adaptation set for welding tab DN30 Type 8201	Union nut G 1¼" / DN30	554873
Adaptation set PG 13.5 for pH armature Type 8200	PG 13.5 with O-ring	554862
Adaptation set for flange connection adapted for GEA Tuchenhagen VARINLINE process connection (DN50...DN125)	Flange adapted for GEA Tuchenhagen VARINLINE process connection	558617
Adaptation set Clamp 2" external Ø 64 mm	Clamp 2"	559744
Electrolyte vessel		
Electrolyte vessel, stainless steel	incl. electrolyte hose set 5 m, compressed air attachment, pipe / wall-mounting unit 1	554850
Electrolyte vessel, stainless steel, with level switch		554851
Operating liquids		
Electrolyte KCl, sterilised, 1 litre plastic bottle (conform to FDA)	Electrolyte reference system	554852
Plastic bottle with septum	For self-filling with alcohol 70 % vol.	554854
Connection cables		
Connection cable for pH probe enamel, 3 m long	6 pin Variopin coupling on pH probe, flexes on transmitter	554855
Connection cable for pH probe enamel, 5 m long		554856
Connection cable for pH probe enamel, 10 m long*		554857
Fittings Type 8201		
Welding tab DN25, 40 mm, straight, 1.4404	DN25/weld attachment straight	554858
Welding tab DN25, 40 mm, sloped, 1.4404	DN25/weld attachment diagonal	554859
Welding tab, DN30, 60 mm, straight, 1.4404	DN30/weld attachment straight	554860
Blind plug for welding tab, DN30, 1.4404**	Union nut G 1¼" / DN30	554861
Nut for blind plug for welding tab, DN30, 1.4404**	G 1¼" / DN30	554872

* Only to be used in exceptional cases, please consult your Bürkert application specialist for application advice.

** Absolutely necessary in order to prevent warping when welding DN30 connecting pieces.

Ordering chart, inspection and retrofit sets

The maintenance sets contain small parts such as O-rings, seals, stainless steel canulas, flexible tubing, couplings etc.
 The retrofit sets contain all parts needed for mounting / dismantling a level switch.

Description	Contents	Article no.
Maintenance sets		
Inspection set for pH probe enamel	2 O-rings 10×2.5 mm EPDM, 2 O-rings 20×2.5 mm silicon, 2 O-rings 23.39×3.53 mm EPDM, 4 items adaptor reinforcement ring PTFE	554876 
Flexible tube set	1 hose connection, 1 hose connector, PTFE hose 4 × 1 length 5 m	554883 
Retrofit sets		
Level switch cplg.	Ultrasonic level switch with M12 fixed connector	561533 
Locking screw M12×1 cplg.	Locking screw PVDF with O-ring FKM	554887 

Please use the attached application questionnaire to describe your process and send it to your Bürkert office to check the suitability. Please complete all three pages.

Questionnaire applications with the enamel pH probe Type 8201

Please fill out this form and send to your local Bürkert Sales Centre with your inquiry or order.

Company:	Contact person:
Customer no.:	Dept:
Address:	Tel./Fax:
Town / Postcode:	E-Mail:

Our process

Process description

continuously pH regulation
 continuously pH control

Temperature range* from to [°C]
 Pressure range* from to [bar]
 pH range* from to [bar]

Concentration of dissolved substances Molarity [mol]
 or proportion [%]
 which substances
 variable concentration No Yes
 if yes, please quote the variation [mol]

Cleaning process**

	Conc. mol	Temp. °C	Time minutes	pH value pH
Cleaning with base	<input type="text"/>	<input type="text"/>	<input type="text"/>	
Cleaning with acid	<input type="text"/>	<input type="text"/>	<input type="text"/>	
Sterilisation with steam		<input type="text"/>	<input type="text"/>	
Sterilisation with product		<input type="text"/>	<input type="text"/>	<input type="text"/>
Sterilisation with aseptic solutions		<input type="text"/>	<input type="text"/>	<input type="text"/>

Other cleaning

* Please chart this data into the diagram time lapse of the process at page 8
 ** Please chart this data into the diagram time lapse of the cleaning process at page 9.

Currently used measuring

Used type of pH measuring system

Following issues are existing

Process time lapse

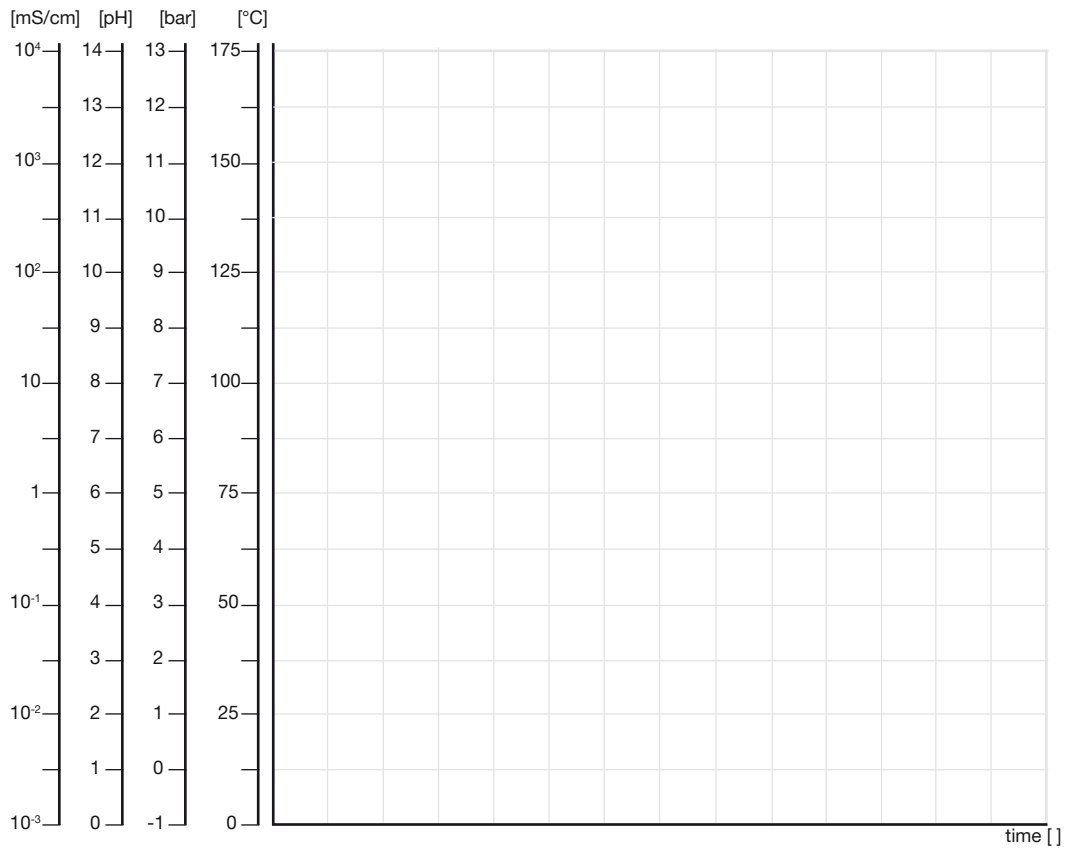

Remarks:

Cleaning time lapse

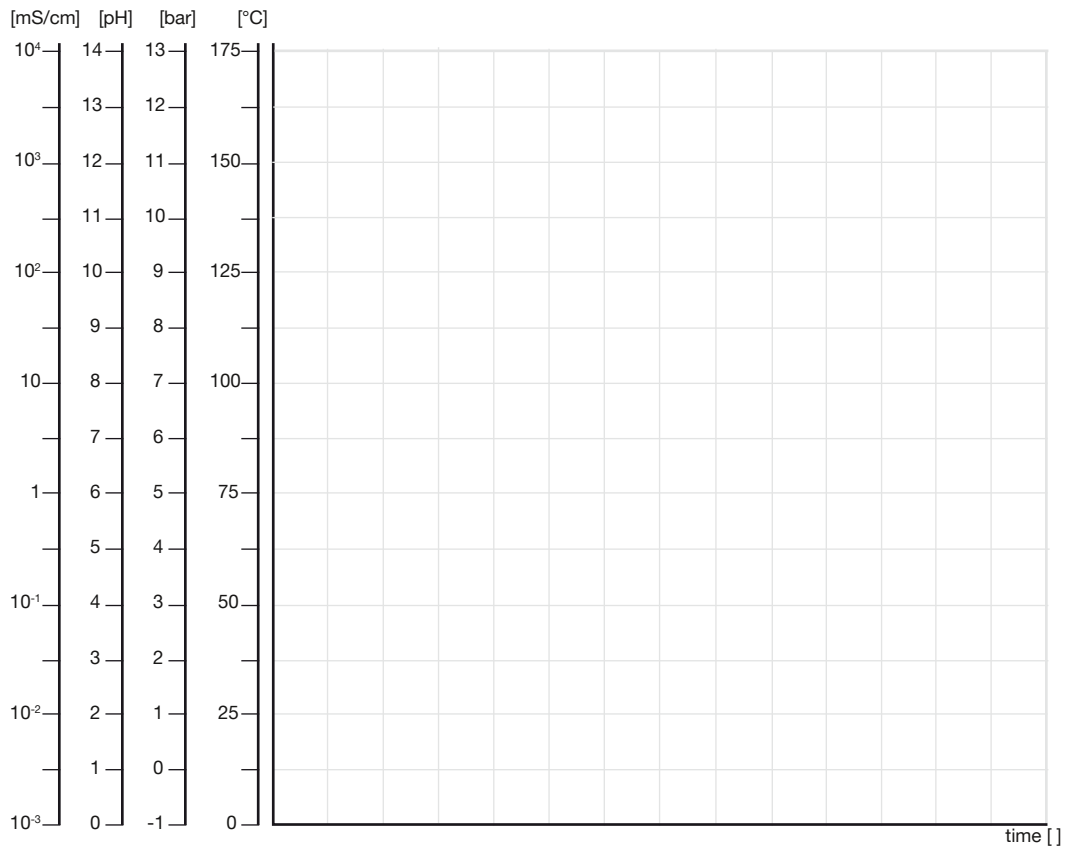

Remarks:

DTS 1000075647 EN Version: W Status: RL (released | freigegeben | valide) printed: 18.01.2019

To find your nearest Bürkert facility, click on the orange box →

www.burkert.com

In case of special application conditions,
please consult for advice.

Subject to alteration.
© Christian Bürkert GmbH & Co. KG

1812/22_EU-en_00891943