

## Electromagnetic Flow Transmitter

- Sensor in solid state technology
- Working as a transmitter and/or as an On/Off controller
- Automatic-calibration of full scale: Teach-In
- Clean in place (CIP)
- FDA approved

Type 8041 can be combined with...



**Type S020**  
INSERTION  
T-fitting

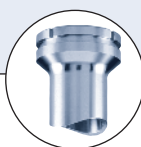

**Type S020**  
Spigot



**Type 8025**  
Universal transmitter /  
batch controller (remote v.)



**Type 2712**  
Globe control valve  
with TopControl

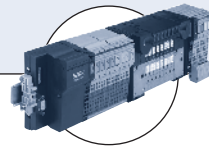

**Type 8644**  
Valve islands with  
electronic I/O

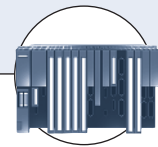

**PLC**

The electromagnetic flow transmitter 8041 has been designed for pipes with diameters ranging from 1/4" to 16" and liquids having a conductivity > 20 µS/cm.

The transmitter is a magmeter made up of an electronic module and a sensor which armature is in PVDF or stainless steel. It is fitted with a 4-20 mA output, a pulse rate output and a relay output. The different parameters can be programmed by means of 5 switches, a push-button and a 10 led bargraph. The version with a stainless steel sensor can be used in applications with higher pressures (232 PSI) and higher temperatures (302°F).

### Technical data

#### General data

<b>Compatibility</b>	with fittings S020 (see corresp. datasheet)
<b>Materials</b>	
Housing, cover, nut	PC (glass fibre reinforced for housing)
PVDF sensor version	PPA (glass fibre reinforced)
St.St. sensor version	Stainless steel / EPDM / PA
Screws / Seal / Cable glands	
Wetted parts materials	
Sensor armature	PVDF or Stainless steel 1.4404/316L
Electrodes	Stainless steel 1.4404/316L
Gaskets	FKM (FDA agreements)
Earth ring (PVDF sensor version)	Stainless steel 1.4404/316L
Electrode holder (St.St. sensor version)	PEEK (FDA agreements)
<b>Electrical connections</b>	Cable glands M 20 x 1.5 - 0.75 mm <sup>2</sup> cross-section, shielded

#### Complete device data (Fitting S020 + transmitter)

<b>Pipe diameter</b>	1/4" to 16" (DN 06 to 400)
<b>Measuring range</b>	0.7 f/s to 32.8 f/s (0.2 m/s to 10 m/s)
<b>Sensor element</b>	Electrodes
<b>Fluid temperature</b>	
PVDF sensor version	32°F up to 176°F (0°C up to 80°C) (depends on fitting)
St.St. sensor version	5°F up to 302°F (-15°C up to 150°C) (depends on fitting)
<b>Fluid pressure max.</b>	see pressure/temperature diagram
PVDF sensor version	87 PSI (PN6)
St.St. sensor version	145 PSI (PN10) (with plastic fitting) - 232 PSI (PN16) (with metal fitting)
<b>Conductivity</b>	min. 20 µS/cm
<b>Accuracy</b>	(for measured value from 3.3 to 32.8 f/s and 5°F < T° < 266°F for st.st. sensor, or 32°F < T° < 176°F for PVDF sensor)
Teach-In	≤ ±2% of Reading <sup>1)</sup>
Standard K-factor	≤ ±4% of Reading <sup>1)</sup>
<b>Linearity</b>	≤ ±( 1% of Reading + 0.1% of FS.* <sup>1)</sup> )
<b>Repeatability</b>	≤ 0.25% of Reading <sup>1)</sup>

1) Under reference conditions i.e. measuring fluid=water, ambient and water temperature=68°F, applying the minimum inlet and outlet pipe straights, matched inside pipe dimensions.

\* F.S.= Full scale (32.8 f/s)

Electrical data	
<b>Power supply</b>	18-36 V DC filtered and regulated (3 wires)
<b>Reversed polarity of DC</b>	protected
<b>Current consumption</b>	≤ 220 mA
<b>Output</b>	
Signal current	4-20 mA, 100 ms refresh rate; max. loop impedance: 1100 Ω at 36 V DC; 330 Ω at 18 V DC.
Frequency	0-240 Hz, duty cycle = 50%±1%; 100 mA max., protected against short-circuits and polarity reversals.
Relay	Normally open or normally closed (depending on wiring), 3A, 250 V AC
<b>Alarm</b>	
Full scale exceeding	22 mA and 256 Hz
Fault signalling	22 mA and 0 Hz
<b>User parameter</b>	Saved in EEPROM
Environment	
<b>Ambient temperature</b>	14°F up to 140°F (-10°C up to +60°C) (operating) -4°F up to 140°F (-20°C up to +60°C) (storage)
<b>Relative humidity</b>	< 80%, non condensated
<b>Altitude max. for operating</b>	6560 ft.
Standards and approvals	
<b>Protection class</b>	IP65
<b>Standard</b>	
EMC	EN 50081-1, EN 61000-6-2
Security	EN 61010-1
Vibration	EN 60068-2-6
Shock	EN 60068-2-27
The device also complies with directive N° 97/23/EC about the devices set under pressure, according to the following methods:	
- Fluids of group 1 according to §1.3b of the directive: PN ≤ 232 PSI and DN < 5"	
- Fluids of group 2 according to §1.3b of the directive: PN ≤ 232 PSI and DN ≤ 8"	
It has been designed and manufactured professionally (Article 3.3). The CE mark is not for pressure. The CE mark complies with directives 89/336/EC (EMC) and 73/23/EC (LVD).	

### Pressure / Temperature diagram

Please be aware of the fluid pressure-temperature dependance according to the respective fitting+transmitter material as shown in the diagrams.

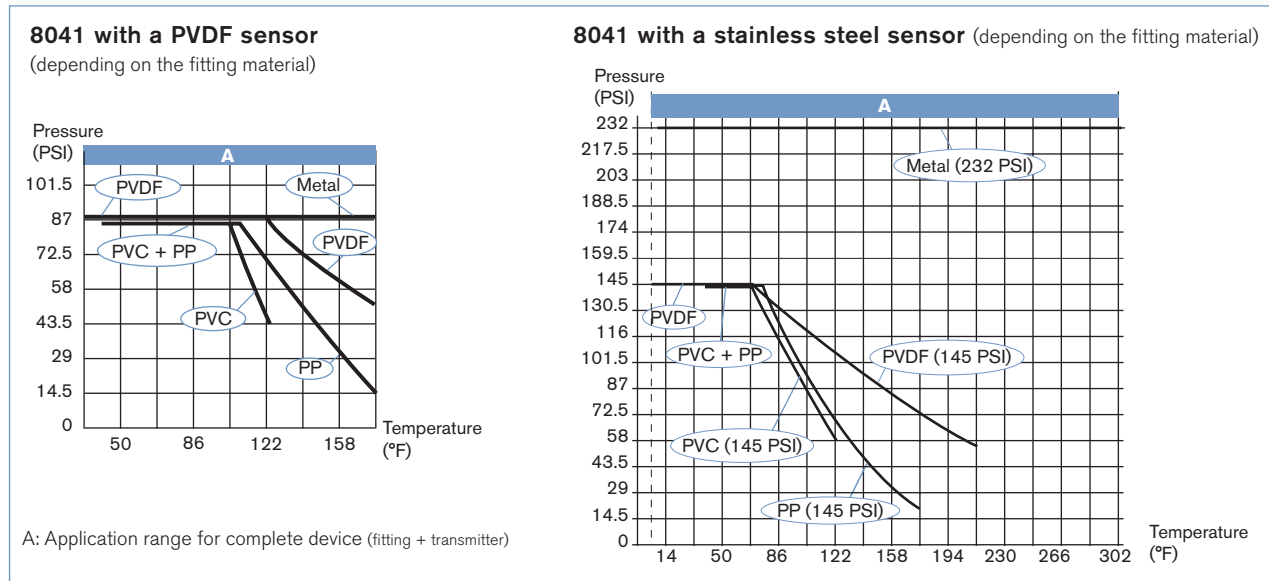

## Main features and programming

### Using as a transmitter

- Programming of the full scale
  - selection of a predefined measuring range: 0 to 2, to 5 or to 10 m/s
  - selection by Teach-In: with the actual max. flow velocity of the application
- 4-20 mA current output
- 0-240 Hz frequency output
- Relay output: switching mode either window or hysteresis, on low or high switching threshold
- Relay time-out
- Filter
- Alarm:
  - for full scale exceeding with 22 mA and 256 Hz
  - for fault signalling with 22 mA and 0 Hz

### Using as an ON/OFF control

- Flow detection with switching thresholds, defined as a percentage of max. flow rate.  
Teach-In of the full scale with an unknown max. flow rate.

## Possible applications

Flow control of fluids, contaminated or not:

- ▶ Waste water treatment
- ▶ Flow control of drinking water (FDA approval)
- ▶ Laundries: measurement and control of the water consumption
- ▶ Swimming pools: pump protection and flow control
- ▶ Food-processing industry: monitoring of the cleaning cycles (FDA approval)
- ▶ Irrigation

## Design

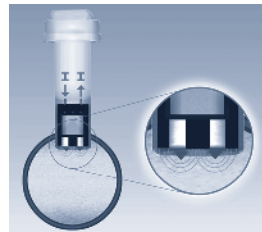

The E-shaped magnetic system inside the sensor induces a magnetic field into the fluid, which is perpendicular to the direction of flow.

Two electrodes are in galvanic contact with the liquid.

Based on the Faraday law a voltage can be measured between these electrodes once a liquid (min. conductivity of 20  $\mu\text{S}/\text{cm}$ )

flows along the pipe. This voltage is proportional to the flow velocity. Using the K-factor for the individual pipe diameter the speed of flow is converted into volume per time.

## Display on PCB

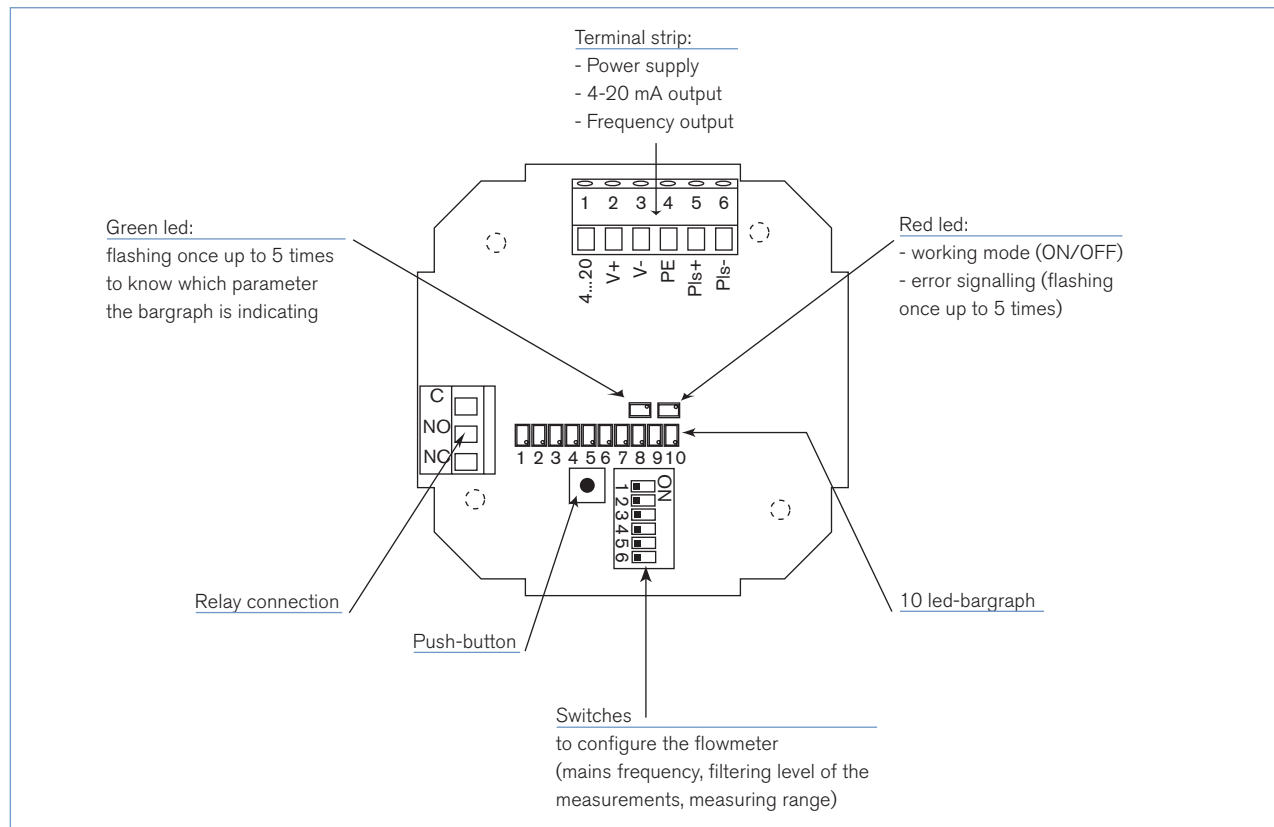

### Installation

The 8041 transmitter can easily be installed into any Bürkert INSERTION fitting system (S020) by just fixing the main nut. Minimum straight upstream and downstream distances must be observed. According to the pipe's design, necessary distances can be bigger or use a flow conditioner to obtain the best accuracy. For more information, please refer to EN ISO 5167-1. EN ISO 5167-1 prescribes the straight inlet and outlet distances that must be complied with when installing fittings in pipe lines in order to achieve calm flow conditions. The most important layouts that could lead to turbulence in the flow are shown below, together with the associated prescribed minimum inlet and outlet distances. These ensure calm, problem-free measurement conditions at the measurement point.

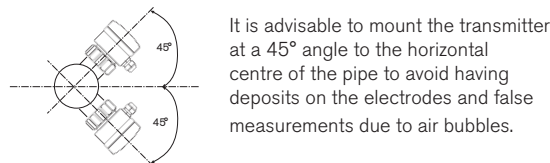
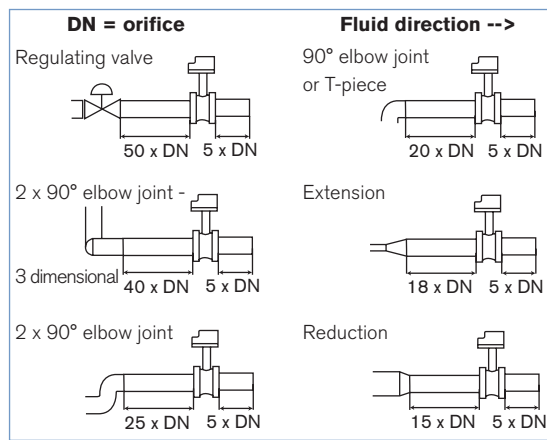

The flow rate transmitter can be installed into either horizontal or vertical pipes. Mount the 8041 transmitter in these correct ways to obtain an accurate flow measurement.

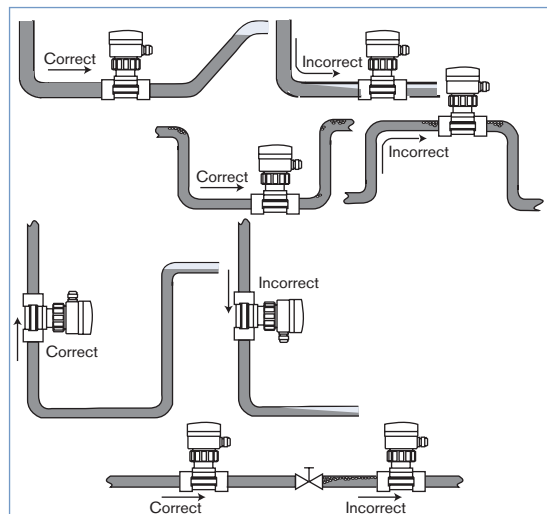

Pressure and temperature ratings must be respected according to the selected fitting material.

The suitable pipe size is selected using the diagram Flow / Velocity / DN.

The flow transmitter is not designed for gas flow measurement.

### Selection of fitting / pipe size

#### Example:

- Specification of nominal flow: 50 gpm
- Ideal flow velocity: 8 f/s
- For these specifications, the diagram indicates a pipe size of 1 1/2" (DN40) [or 2" (DN50) for (\*) mentioned fittings]

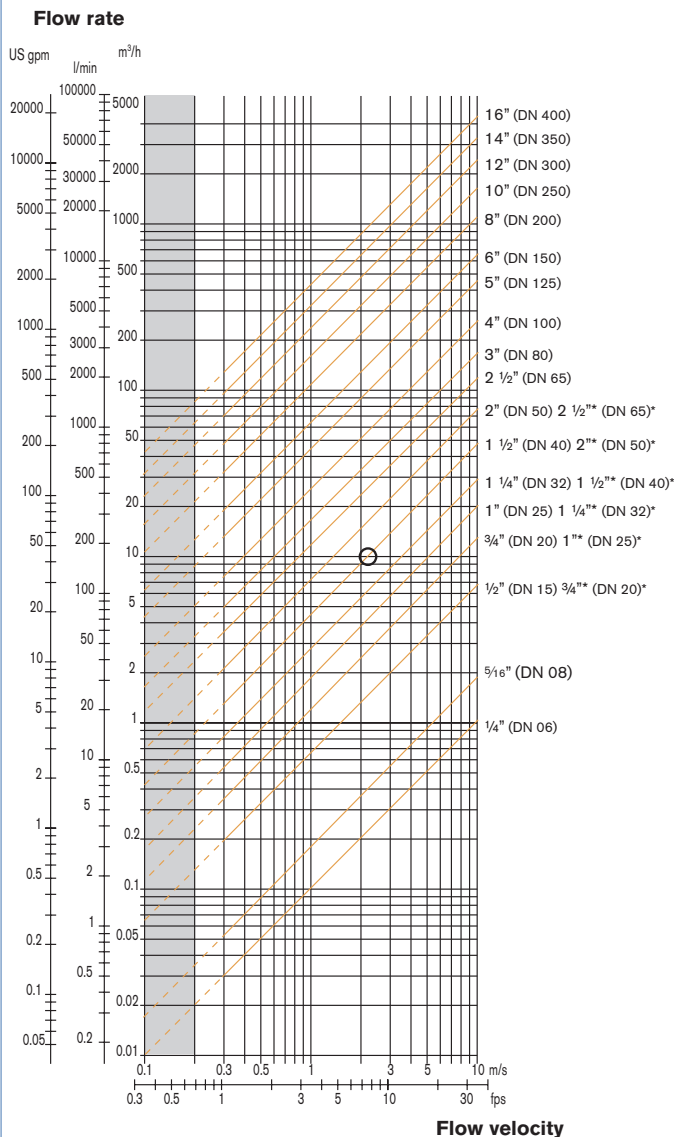

\* For weld ends fittings SMS3008 or BS4825/ASME BPE, or Tri-Clamp® fittings SMS3017/ISO2852 or BS4825/ASME BPE.

Tri-Clamp® is a registered Trademark of Alfa Laval Inc.

## Dimensions [mm]

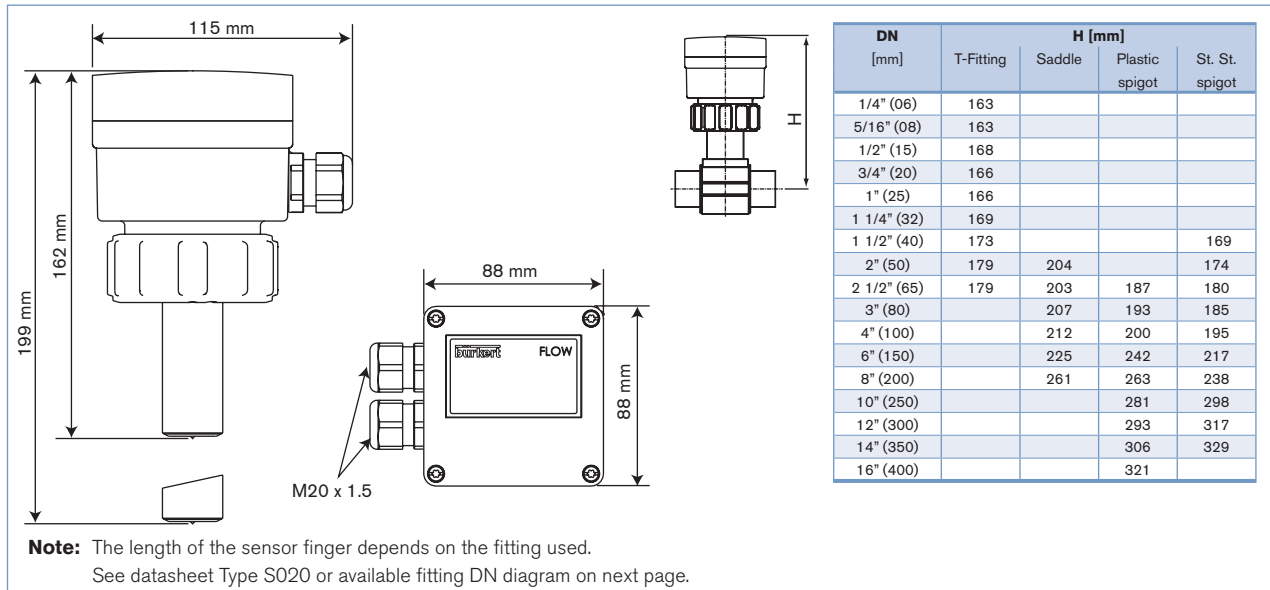

## Ordering chart for transmitter Type 8041 - for fitting S020 (see corresp. datasheet)

Voltage supply	Output	Relay	Housing material	Gaskets	Sensor version	Electrical connection	Item no.
18-36 V DC	4-20 mA, frequency	1	PC	FKM	short, PVDF	2 cable glands	558 064
					long, PVDF	2 cable glands	558 065
			PPA	FKM	short, stainless steel	2 cable glands	552 779
					long, stainless steel	2 cable glands	552 780

**Note:** 1 Kit 558 102 and 1 relay connection kit 552 812 are supplied with each transmitter.

## Ordering chart - accessories for transmitter Type 8041 (has to be ordered separately)

Specifications	Item no.
Set with 2 cable glands M20 x 1.5 + 2 neoprene flat seals for cable gland or plug + 2 screw-plugs M20 x 1.5 + 2 multiway seals 2 x 6 mm	449 755
Set with 2 reductions M20 x 1.5 /NPT1/2" + 2 neoprene flat seals for cable gland or plug + 2 screw-plugs M20 x 1.5	551 782
Set with 1 stopper for unused cable gland M20 x 1.5 + 1 multiway seal 2 x 6 mm for cable gland + 1 green FKM gasket for the sensor + 1 mounting instruction sheet	558 102
Ring	619 205
PC union nut	619 204
PPA union nut	440 229
Set with 1 green FKM and 1 black EPDM gasket	552 111
Relay connection kit with 1 screw terminal strip + 1 protection cap + 1 rilsan + 1 mounting instruction sheet	552 812
Calibration certificate	550 676
FDA - Approval	449 788

Ordering chart for remote electronics Type 8025 which can be connected to the 8041

Version	Description	Voltage supply	Output	Relays	Sensor version	Electrical connection	Item no.
Panel	Type 8025 "Universal", 2 totalizers	18-30 V DC	4-20 mA, pulse	None	8041	Terminal strip	419 538
				2	8041	Terminal strip	419 537
	Type 8025 "Batch", 2 totalizers, 1 flowrate	18-30 V DC	-	2	8041	Terminal strip	419 536
Wall	Type 8025 "Universal", 2 totalizers	18-30 V DC	4-20 mA, pulse	None	8041	3 cable glands	419 541
				2	8041	3 cable glands	419 540
	115-230 V AC	4-20 mA, pulse	None	8041	3 cable glands	419 544	
	Type 8025 "Batch", 2 totalizers, 1 flowrate	18-30 V DC	-	2	8041	5 cable glands	433 740
		115-230 V AC	-	2	8041	5 cable glands	433 741

Interconnection possibilities with other Bürkert flow sensors

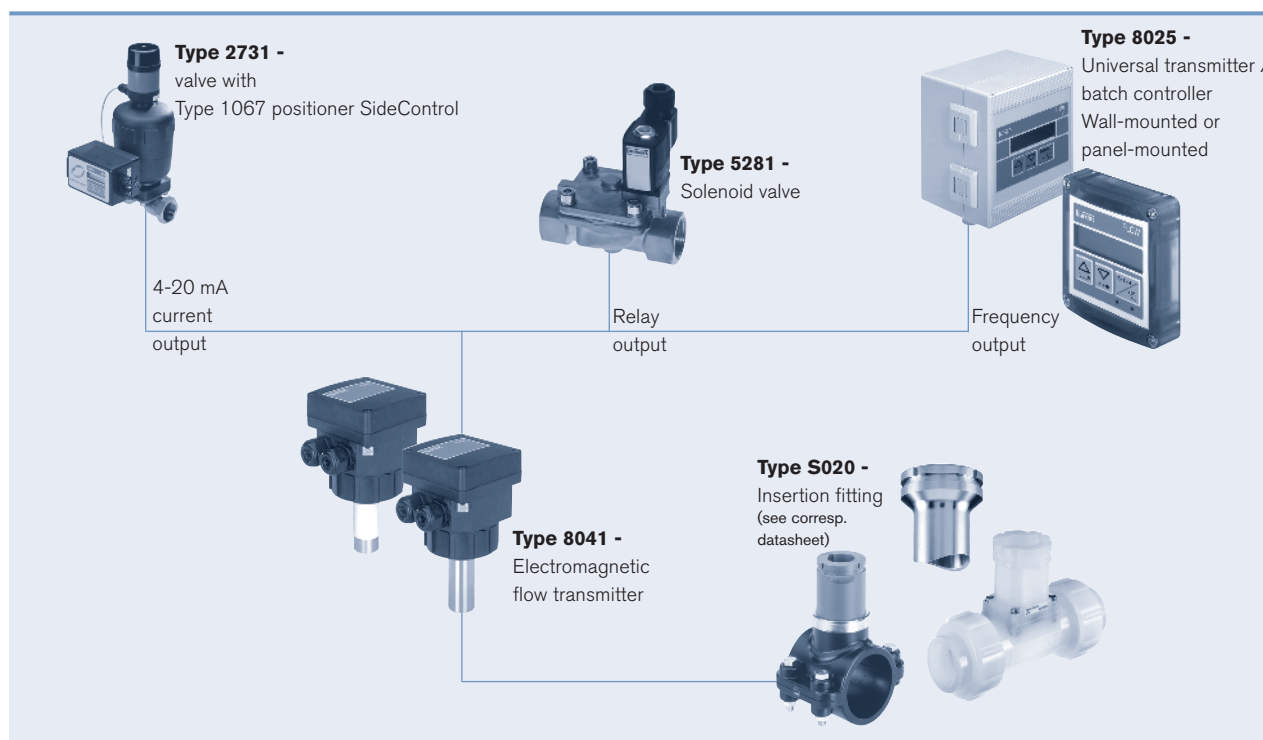

Available S020 Fitting DN	T-fitting S020	1/4" (DN 06)		2 1/2" (DN65)		
		(1)	Short sensor	Short sensor	Long sensor	Long sensor
Welding tab S020				2" (DN50)	8" (DN200)	14" (DN350)
Fusion spigot S020				2 1/2" (DN65)	4" (DN100)	16" (DN400)
Saddle S020 carbon steel				2 1/2" (DN65)	Long sensor	
Saddle S020 PVC				2" (DN50)	4" (DN100)	8" (DN200)
				Short sensor	Long sensor	

(1) DN 06 and DN 08 in stainless steel only

In case of special application conditions, please consult for advice.

We reserve the right to make technical changes without notice.

0701/4\_US-en\_1000082468