

Inline flowmeter with paddle wheel



- Up to PN16, size of measurement pipes: DN06 to DN65
- Display for indication of flow rate and volume with two flow totalizers
- Automatic calibration using Teach-In
- All outputs can be checked without the need of actual flow

Type 8035 can be combined with...



Type 8611
Universal controller
eControl



Type 8619
multiCELL
transmitter/controller



Type 8802
ELEMENT
control valve system

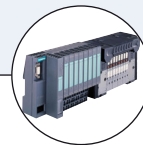

Type 8644
Process actuation
control system
AirLINE

The 8035 flowmeter is specially designed for use in neutral, slightly aggressive, solid free liquids.

The flowmeter is made up of a compact sensor-fitting with paddle wheel (S030) and a transmitter (SE35) quickly and easily connected together by a quarter-turn. The Bürkert designed sensor-fitting system ensures simple installation of the devices into all pipes from DN06...DN65.

The flowmeter with paddle wheel sensor is available in two versions:
- standard output signal or
- battery powered indicator/totalizer version without output.

General technical data															
Compatibility	With Bürkert Inline sensor-fitting S030 (see corresponding datasheet)														
Materials	<table border="0"> <tr> <td>Housing, cover, lid, nut</td> <td>PC</td> </tr> <tr> <td>Front panel foil / Screws</td> <td>Polyester / Stainless steel</td> </tr> <tr> <td>Cable plug or glands</td> <td>PA</td> </tr> <tr> <td>Wetted parts</td> <td></td> </tr> <tr> <td> Sensor-fitting, sensor armature</td> <td>Brass, stainless steel 1.4404/316L, PVC, PP or PVDF</td> </tr> <tr> <td> Paddle wheel</td> <td>PVDF</td> </tr> <tr> <td> Axis and bearings / Seal</td> <td>Ceramics (Al₂O₃) / FKM (EPDM included, but not mounted)</td> </tr> </table>	Housing, cover, lid, nut	PC	Front panel foil / Screws	Polyester / Stainless steel	Cable plug or glands	PA	Wetted parts		Sensor-fitting, sensor armature	Brass, stainless steel 1.4404/316L, PVC, PP or PVDF	Paddle wheel	PVDF	Axis and bearings / Seal	Ceramics (Al ₂ O ₃) / FKM (EPDM included, but not mounted)
Housing, cover, lid, nut	PC														
Front panel foil / Screws	Polyester / Stainless steel														
Cable plug or glands	PA														
Wetted parts															
Sensor-fitting, sensor armature	Brass, stainless steel 1.4404/316L, PVC, PP or PVDF														
Paddle wheel	PVDF														
Axis and bearings / Seal	Ceramics (Al ₂ O ₃) / FKM (EPDM included, but not mounted)														
Display	15 × 60 mm, 8-digit LCD, alphanumeric, 15 segments, 9 mm high														
Electrical connections	<table border="0"> <tr> <td>Standard signal version</td> <td>Cable plug or cable glands M20 × 1.5</td> </tr> <tr> <td>Battery indicator/totalizer version</td> <td>None</td> </tr> </table>	Standard signal version	Cable plug or cable glands M20 × 1.5	Battery indicator/totalizer version	None										
Standard signal version	Cable plug or cable glands M20 × 1.5														
Battery indicator/totalizer version	None														
Connection cable	<table border="0"> <tr> <td>Cable with maximum operating temperature greater than 80 °C (90 °C for UL-Recognized version)</td> <td></td> </tr> <tr> <td>max. 50 m, shielded, 0.2...1.5 mm² wires cross-section</td> <td></td> </tr> <tr> <td>External diameter (cable)</td> <td>5...8 mm (with cable plug), 6...12 mm or 3...5 mm when using a multiway seal (with cable glands)</td> </tr> <tr> <td>Cross-section (local earthing wire)</td> <td>0.75 mm²</td> </tr> </table>	Cable with maximum operating temperature greater than 80 °C (90 °C for UL-Recognized version)		max. 50 m, shielded, 0.2...1.5 mm ² wires cross-section		External diameter (cable)	5...8 mm (with cable plug), 6...12 mm or 3...5 mm when using a multiway seal (with cable glands)	Cross-section (local earthing wire)	0.75 mm ²						
Cable with maximum operating temperature greater than 80 °C (90 °C for UL-Recognized version)															
max. 50 m, shielded, 0.2...1.5 mm ² wires cross-section															
External diameter (cable)	5...8 mm (with cable plug), 6...12 mm or 3...5 mm when using a multiway seal (with cable glands)														
Cross-section (local earthing wire)	0.75 mm ²														
Environment															
Ambient temperature (operation and storage)	<table border="0"> <tr> <td>0...+60 °C (+32...+140 °F) (12...36 V DC version)</td> </tr> <tr> <td>0...+50 °C (+32...+122 °F) (115/230 V AC version)</td> </tr> <tr> <td>0...+55 °C (+32...+131 °F) (batteries version)</td> </tr> </table>	0...+60 °C (+32...+140 °F) (12...36 V DC version)	0...+50 °C (+32...+122 °F) (115/230 V AC version)	0...+55 °C (+32...+131 °F) (batteries version)											
0...+60 °C (+32...+140 °F) (12...36 V DC version)															
0...+50 °C (+32...+122 °F) (115/230 V AC version)															
0...+55 °C (+32...+131 °F) (batteries version)															
Relative humidity	≤ 80 %, without condensation														
High above sea level	Max. 2000 m														

8035 / SE35

Inline

bürkert

Pressure/temperature chart

Complete device data (sensor-fitting S030 + transmitter SE35)	
Pipe diameter	DN06...DN65
Measuring range	0.3...10 m/s
Fluid temperature with fitting in PVC/ PP PVDF, brass or stainless steel	0...+50 °C (+32...+122 °F) / 0...+80 °C (+32...+176 °F) -15...+100 °C (+5...+212 °F)
Fluid pressure max.	PN10 (145.1 PSI) (with plastic fitting) - PN16 (232.16 PSI) (with metal fitting - PN40 on request, see S030 datasheet) - see Pressure/Temperature diagram
Viscosity / Particles rate	300 cSt max. / 1 % max. (size: 0.5 mm max.)
Measurement deviation ¹⁾ Teach-In Standard K-factor	±1 % of the measured value ²⁾ (at Teach-In flow rate value) ±2.5 % of the measured value ²⁾
Linearity	±0.5 % of F.S.* ²⁾
Repeatability	±0.4 % of the measured value ²⁾
Electrical data	
Power supply (V+) Standard signal version	12...36 V DC ±10 %, filtered and regulated, SELV (safety extra low voltage) circuit with a non dangerous energy level or 115/230 V AC 50/60 Hz (see technical specifications 115/230 V AC)
Battery indicator/totalizer version	4 x 1.5 V DC non-rechargeable alkaline AA batteries, lifetime 4 years at 20 °C (68 °F)
Characteristics of the power source (not provided) of UL-Recognized devices	Limited power source (according to § 9.4 of the UL 61010-1 standard) or, Class 2 type power source (according to the 1310/1585 and 60950-1 standards)
Reversed polarity of DC	protected
Current consumption with sensor Version 12...36 V DC	Without pulse output consumption ≤70 mA (with relays) ≤25 mA (without relays)
Output	
Standard signal version Pulse (potential free transistor)	Polarized, NPN or PNP (wiring dependant); function: pulse output, adjustable pulse value, 2.5...400 Hz; 5...36 V DC; 100 mA, line drop at 100 mA: 2.5 V DC; duty cycle: 0.5 Galvanic insulation and protected against overvoltage, polarity reversals and short circuit
Relay	2 relays, hysteresis, adjustable thresholds, normally open, 230 V AC/3 A or 40 V DC/3 A (resistive load)
Current	4...20 mA (3-wire with relays; 2-wire without relay), sourcing or sinking (wiring dependant), max. loop impedance: 900 Ω at 30 V DC, 600 Ω at 24 V DC, 50 Ω at 12 V DC, 800 Ω with a 115/230 V AC voltage supply
Response time (10%...90%)	6 s (default)
Battery indicator/totalizer version	None
4...20 mA output uncertainty	±1 % of range
Technical specifications 115/230 V AC	
Voltage supply available inside the device	27 V DC regulated, max. current: 125 mA integrated protection: fuse 125 mA temporised power: 3 VA
Standards, directives and certifications	
Protection class (according to EN 60529)	IP65 with device wired, cover and lid screwed tight and cable plug or glands mounted and tightened or with blind plug if not used
Standards and directives CE	The applied standards, which verify conformity with the EU Directives, can be found on the EU Type Examination Certificate and/or the EU Declaration of conformity (if applicable) Complying with article 4, §1 of 2014/68/EU directive*
Pressure	
Certification UL-Recognized for US and Canada	UL 61010-1 + CAN/CSA-C22.2 No. 61010-1

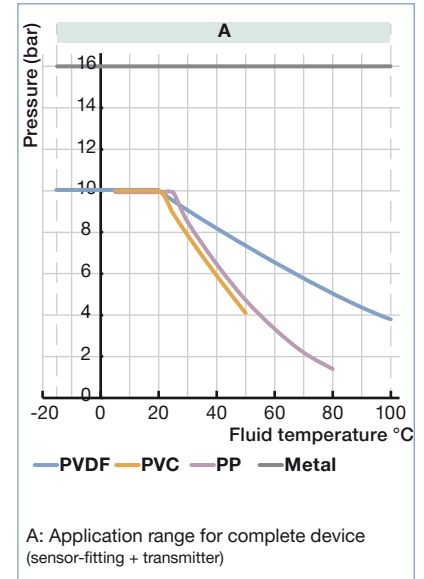

* F.S. = Full scale (10 m/s)

¹⁾ = "measurement bias" as defined in the standard JCGM 200:2012

²⁾ Under reference conditions i.e. measuring fluid = water, ambient and water temperature = 20 °C (68 °F), while maintaining the minimum inlet and outlet distances and the appropriate internal diameter of the pipes.

! If the device is mounted in a humid environment or outside, then the maximum voltage allowed is **35 V DC** instead of 36 V DC.

* For the 2014/68/EU pressure directive, the device can only be used under the following conditions (depends on max. pressure, pipe diameter and fluid).

Type of Fluid	Conditions
Fluid group 1, article 4, §1.c.i	DN ≤ 25
Fluid group 2, article 4, §1.c.i	DN ≤ 32 or PN*DN ≤ 1000
Fluid group 1, article 4, §1.c.ii	DN ≤ 25 or PN*DN ≤ 2000
Fluid group 2, article 4, §1.c.ii	DN ≤ 200 or PN ≤ 10 or PN*DN ≤ 5000

Specific technical data of UL-Recognized products for US and Canada	
Relay output	30 V AC and 42 V peak max./3 A or 60 V DC max./1 A
Ambient temperature	0...+40 °C (32...+104 °F)
Relative humidity	max. 80 %, without condensation
Intended for an inner pollution	Pollution degree 2 according to EN 61010-1
Installation category	Category I according to UL 61010-1 – indoor use

Operation and display

The device is calibrated by means of the K-factor (conversion coefficient) which is either entered or determined via the Teach-In function. User adjustments, such as measuring range, engineering units, pulse output and filtering level (damping) are carried out via the device operators interface.

The operation is specified according to two or three levels, depending on the flowmeter version:

	Indication in operating mode/display	Parameter definition	Test
Flowmeter	<ul style="list-style-type: none"> • flow rate • output current • main totalizer • daily totalizer with reset function 	<ul style="list-style-type: none"> • language • engineering units • K-factor/Teach-In function • measuring range 4...20 mA • pulse output • relay (option) • filter (damping) • reset main totalizer 	<ul style="list-style-type: none"> • alteration of basic adjustment (offset, span) • frequency test of sensor • flow simulation
Battery indicator/totalizer	<ul style="list-style-type: none"> • flow rate • main totalizer • daily totalizer with reset function 	<ul style="list-style-type: none"> • language • engineering units • K-factor/Teach-In function • filter (damping) • reset main totalizer 	<ul style="list-style-type: none"> • frequency test of sensor • warning and fault messages generating

Description of the navigation keys and the LEDs status

Scrolling up the parameters
Increase the selected digit

Scrolling down the parameters
Selecting the digit on the left

Reading the messages in the information menu²⁾
Auto scroll the indications²⁾
Battery level display²⁾

Large digital display with 8 characters
(4 digital characters and 4 alphanumeric characters) indicating;
– the measured flow
– the value of the current output
– the value of the main totalizer
– the value of the daily totalizer

Selecting the displayed parameter
Validating the setting

Device LED status²⁾:
see following table

LED status of relay 2¹⁾

LED status of relay 1¹⁾

¹⁾ Not for battery versions
²⁾ Only for battery versions

Device LED status	Status of the device
Blinking orange	A warning message is generated in the information menu.
Blinking red	A fault message is generated

Design and principle of operation

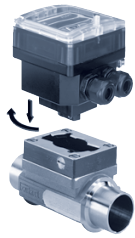

The electronic housing of the 8035 integrates the electronic board with display, setting parameter keys and also a transducer (coil for battery indicator/totalizer version or Hall for other versions). The paddle wheel is mounted in the sensor-fitting. The output signals are provided via a cable plug or two cable glands (according to the flowmeter version). Bürkert designed sensor-fitting ensures simple installation of the Bürkert flowmeter into pipes from DN06...DN65.

When liquid flows through the pipe, the paddle wheel with 4 inserted magnets is set in rotation, producing a measuring signal in the sensor (Coil or Hall sensor). The frequency modulated induced voltage is proportional to the flow velocity of the fluid.

A conversion coefficient (K-factor, available in the instruction manual of the S030 sensor-fitting), specific to each pipe (size and material) enables the conversion of this frequency into flow rate.

The electronic component converts the measured signal into several outputs (according to the flowmeter version) and displays the actual value. Totalizers are used to obtain the volume of fluid passed through the pipe.

Installation

The SE35 transmitter can easily be installed into any Bürkert Inline sensor-fitting system (S020), by means of a quarter-turn.

Minimum straight upstream and downstream distances must be observed. According to the pipe's design, necessary distances can be bigger or use a flow conditioner to obtain the best accuracy.

For more information, please refer to EN ISO 5167-1.

EN ISO 5167-1 prescribes the straight inlet and outlet distances that must be complied with when installing fittings in pipe lines in order to achieve calm flow conditions. The most important layouts that could lead to turbulence in the flow are shown below, together with the associated prescribed minimum inlet and outlet distances.

These ensure calm, problem-free measurement conditions at the measurement point.

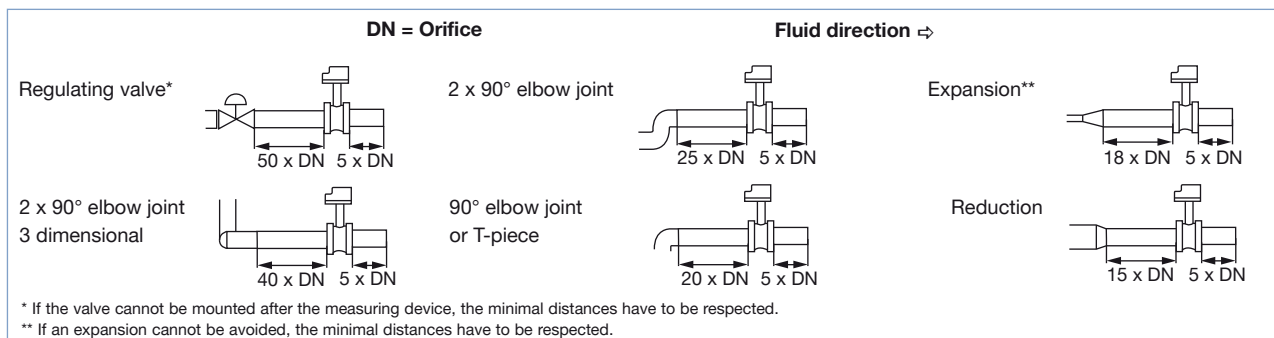

The device can be installed into either horizontal or vertical pipes.

Important criteria for this are; ensure that the measurement pipe is fully filled and that the measurement pipe is air bubble free.

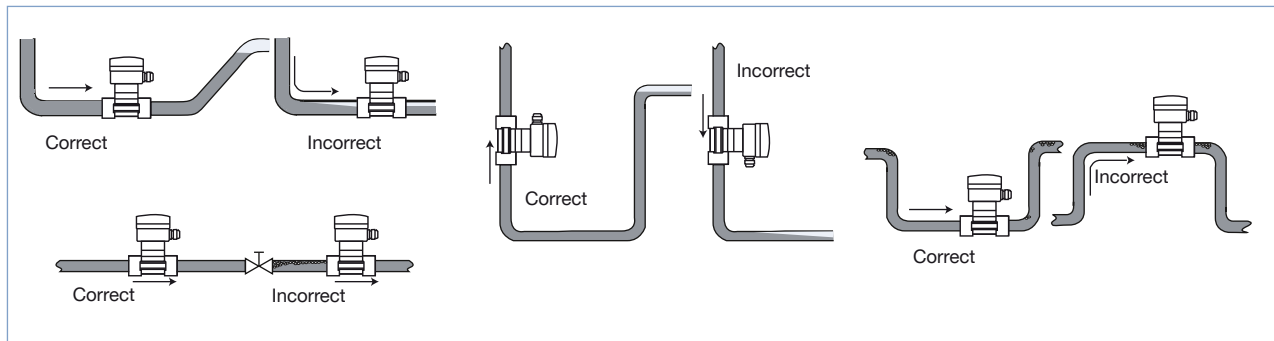

Pressure and temperature ratings must be respected according to the selected fitting material.

The suitable pipe size is selected using the diagram Flow/Velocity/DN.

The flowmeter is not designed for gas and steam flow measurement.

Diagram Flow/Velocity/DN

Example:

- Specification of nominal flow: 10 m³/h
- Ideal flow velocity: 2...3 m/s

For these specifications, the diagram indicates a pipe size of DN40 (or DN50 for (*) mentioned fittings)

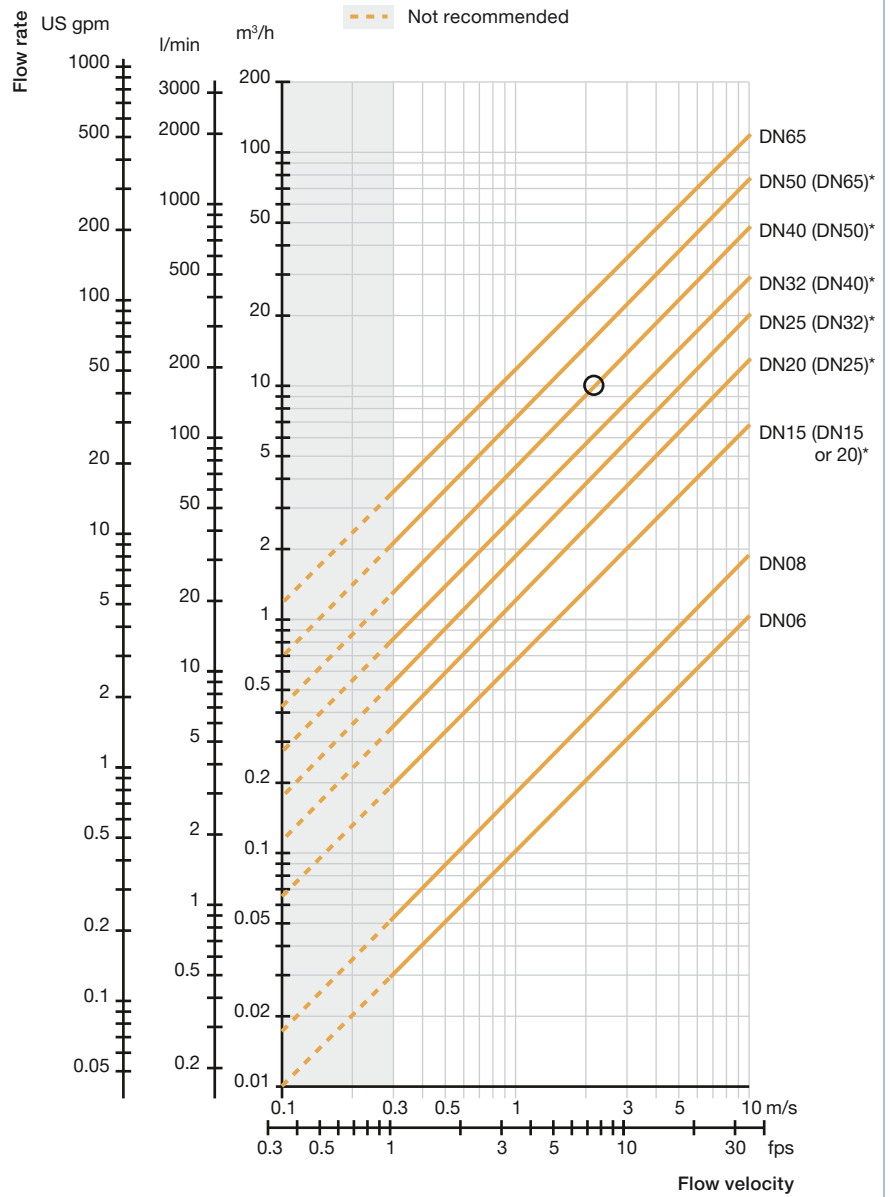

* for following fittings with:

- external threads acc. to SMS 1145
- weld ends acc. to SMS 3008, BS4825-1/ASME BPE/DIN 11866 series C or DIN 11850 series 2/DIN 11866 series A/DIN EN 10357 series A
- Clamp acc. to SMS 3017, BS 4825-3/ASME BPE or DIN 32676 series A

Dimensions [mm] of flowmeter

SE35 Transmitter

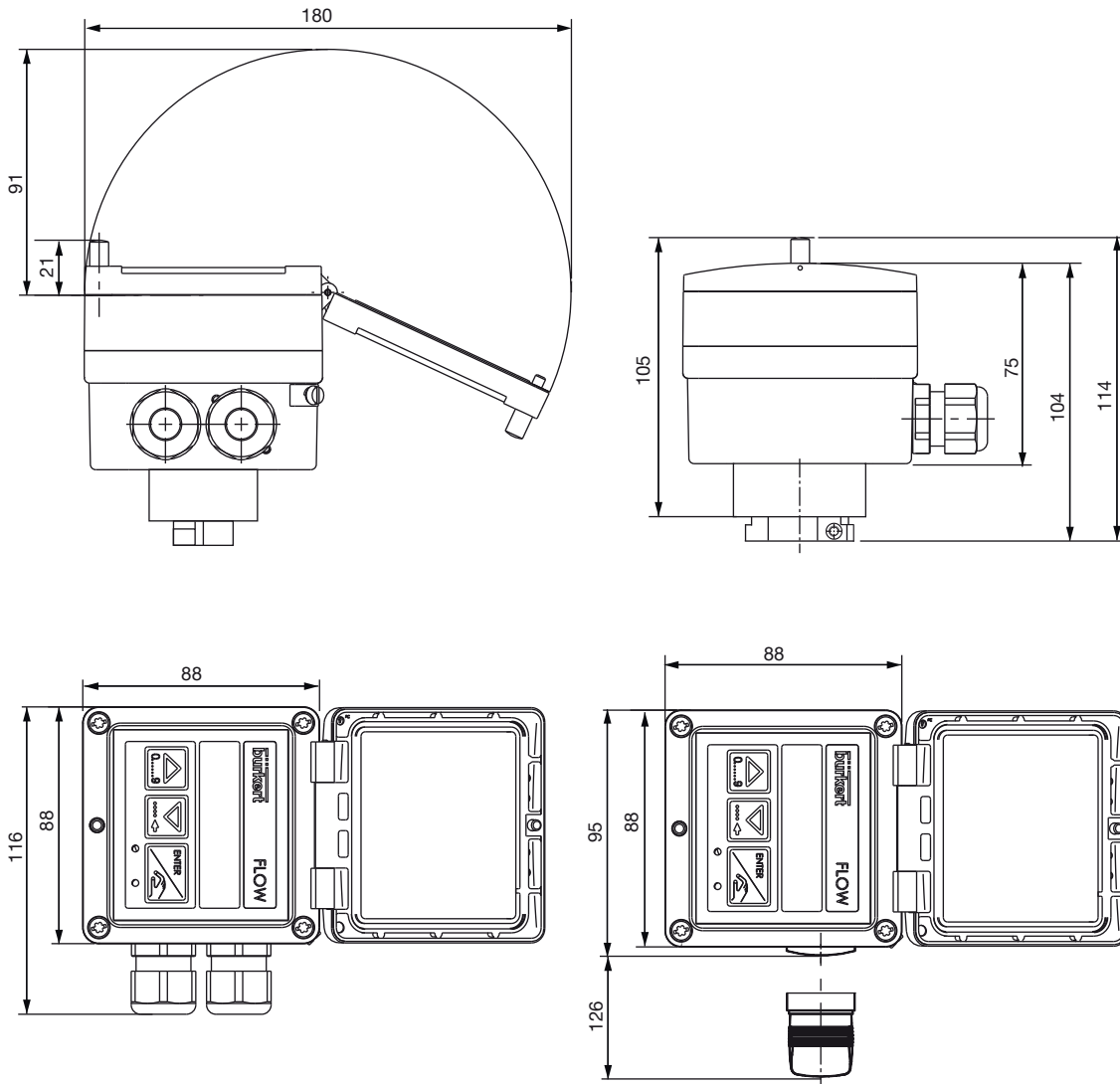

Flowmeter (SE35 transmitter + S030 sensor-fitting)

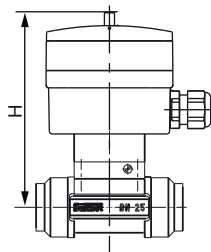

DN	H
06	134
08	134
15	139
20	137
25	137
32	140
40	144
50	151
65	151

Ordering information and chart for flowmeter

A complete 8035 flowmeter with integrated paddle wheel sensor consists of an SE35 Inline transmitter and a Bürkert S030 Inline sensor-fitting.

The following information is necessary for the selection of a complete device:

- **Article no.** of the desired compact **SE35** transmitter (see ordering chart below)
- **Article no.** of the selected **S030** Inline fitting (see separate datasheet)

More info.

→ You have to order the two components separately.

When you click on the orange box "More info.", you will come to our website for the resp. product where you can download the datasheet.

Specifications	Voltage supply	Output	Relays	Sensor version	Certification	Electrical connection	Article no.
Standard output signal transmitter, 2 totalizers	12...36 V DC	4...20 mA (2 wires) + pulse	None	Hall	-	Cable plug EN 175301-803	444005
				Hall	UL-Recognized for US and Canada	2 cable glands	444006
		4...20 mA (3 wires) + pulse	2	Hall	-	2 cable glands	444007
			Hall	UL-Recognized for US and Canada	2 cable glands	553433	
	115/230 V AC	4...20 mA (2 wires) + pulse	None	Hall	-	2 cable glands	423922
		4...20 mA (3 wires) + pulse	2	Hall	-	2 cable glands	423924
Indicator, 2 totalizers	4 x 1.5 V DC AA Batteries	—	None	Coil	-	None	423921

Ordering chart - accessories (has to be ordered separately)

Specifications	Article no.
Set with 2 cable glands M20 x 1.5 + 2 neoprene flat seals for cable gland or plug + 2 screw plugs M20 x 1.5 + 2 multiway seals 2 x 6 mm	449755
Set with 2 reductions M20 x 1.5 /NPT 1/2" + 2 neoprene flat seals for cable gland or plug + 2 screw plugs M20 x 1.5	551782
Set with 1 stopper for unused cable gland M20 x 1.5 + 1 multiway seal 2 x 6 mm for cable gland + 1 black EPDM seal for the sensor + 1 mounting instruction sheet	551775
Cable plug with cable gland (Type 2508)	438811
Cable plug with NPT 1/2" reduction without cable gland (Type 2509)	162673

Interconnection possibilities with other Bürkert flowmeters

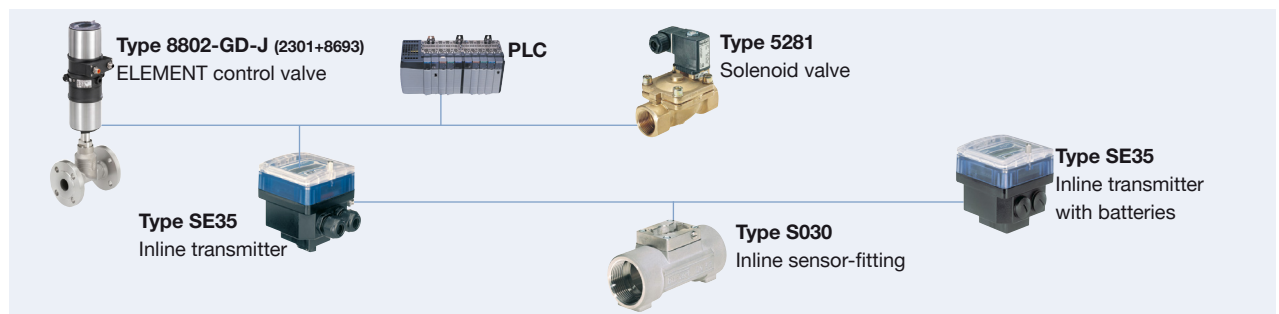

To find your nearest Bürkert facility, click on the orange box →

www.burkert.com

In case of special application conditions, please consult for advice.

Subject to alteration.
© Christian Bürkert GmbH & Co. KG

1804/12_EU-en_00891786