

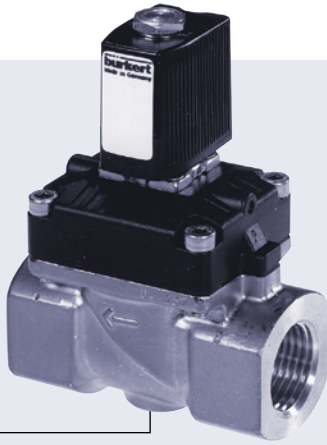



2/2-way Solenoid Valve with Servo Diaphragm



- Waterhammer-free, low noise
- Low power consumption, not really needed when used on a PLC
- Port connection NPT 3/8 to NPT 1
- Pressure range 7 up to 145 PSI¹⁾ (0.5 up to 10 bar¹⁾)
- Approvals:   

Type 6211 can be combined with...

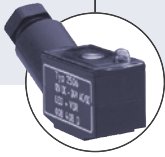

Type 2506

Cable plug to
DIN EN 175301-803²⁾
Form C



Type 2507

Cable plug
industrial standard
Form B



Type 2510

ASI-
cable plug

The Type 6211 is a servo-assisted normally closed 2/2-way solenoid valve with a servo-diaphragm, media separated, for use especially with neutral fluids and gaseous media. The valve is having a low power consumption, low weight and a compact body.

The valve is normally closed by spring force. Energized, the solenoid opens the pilot valve first. Then the medium pressure opens the valve against the pressure drop above the diaphragm. The valve opens.

The special design and geometry of the inner parts of the valve result in a soft closing function when the pressure peaks are only very small.

Circuit function A

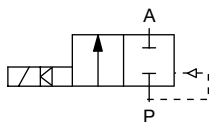

2/2-way valve,
servo-assisted,
normally closed

Technical data	
Body material	Brass (DIN 50930-6)
Body cover	Noryl
Sealing material	NBR, EPDM, FKM
Media	
NBR	neutral gases and fluids (e.g. compressed air, municipal gas, natural gas, water, hydraulic oil, oil, fat without additives);
EPDM	oil and fat-free media (e.g. hot water, alkaline washing and bleaching lyes);
FKM	hot air, per-solutions, hot oils and oils with additives
Medium temperature	
NBR	32 to 158°F (0 to +70°C)
EPDM	14 to 158°F (-10 to +70°C)
FKM	32 to 158°F (0 to +70°C)
Ambient temperature	max. 131°F (+55°C)
Port connection	NPT 3/8 to NPT 1
Operating voltage	24 V DC 24 / 120 / 240 V / 60 Hz
Power consumption	4 W
Inrush	9 VA AC, 4 W DC
Hold	6 VA AC, 4 W DC
Voltage tolerance	±10%
Duty cycle	100% continuous rating
Electrical connection	<ul style="list-style-type: none"> ▪ Tag connector sideways ▪ acc. to DIN EN 175301-803²⁾ Form C for cable plug Type 2506 (see <i>Ordering chart for accessories</i>) ▪ acc. to DIN 43650 Form B (industrial standard) for cable plug Type 2507 (see <i>Ordering chart for accessories</i>)
Installation	as required, preferably with actuator upright
Weight	see table <i>Response times</i>
Protection class	IP 65 with cable plug

¹⁾ Pressure rate [bar]: Overpressure with respect to atmospheric pressure
²⁾ so far DIN 43650

Response times

Orifice	C _v value water [GPM]	Port connection	Pressure range ²⁾ [bar] ¹⁾	Response times		Weight [kg]
				Opening [ms]	Closing [ms]	
10	2.23	NPT 3/8, NPT 1/2	0.5–10	20	130	0.31
13	4.23	NPT 1/2, NPT 3/4	0.5–10	30	240	0.44
20	9.76	NPT 3/4, NPT 1	0.5–10	350	600	1.03

¹⁾ Pressure data [bar]: Overpressure with respect to atmospheric pressure

²⁾ For opening the full cross-section, a pressure difference of 7 PSI (0.5 bar) is required.

- C_v value [GPM]: Flow rate value for water, measured at 68°F (+20°C) and 14.5 PSI (1 bar)¹⁾ pressure differential over a fully opened valve.
- Response times [ms]: measured at valve outlet at 87 PSI (6 bar)¹⁾ and 68°F (+20°C)
Opening: pressure build-up 0 ... 90%, Closing: pressure relief 100 ... 10%

Material

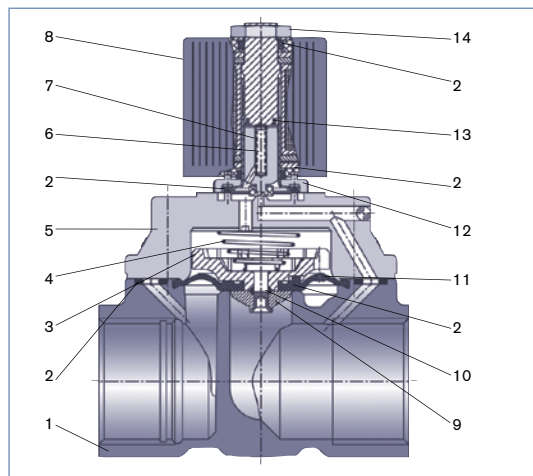

1	Body	Brass
2	O-ring	NBR, FKM, EPDM
3	Diaphragm support	PPS
4	Spring	SS1.4310
5	Body cover	Noryl
6	Plunger	SS1.4105
7	Spring	SS1.4310
8	Coil	SS1.4105
	DIN EN 175301-803 ^{*)} C	PA
	DIN 43650	
	(industrial standard)	Epoxy
9	Diaphragm holder	Brass, PPS
10	Bolt	SS1.4401
11	Diaphragm	NBR, FKM, EPDM
12	Flange	Surface Zn3glc
13	Shading ring	Cu
14	Locknut	9SMnPb28K
		(Surface Zn5glcA)

^{*)} so far DIN 43650

Dimensions [mm]

Coil acc. to DIN EN 175301-803^{*)} Form C for cable plug 2506

Coil acc. to DIN 43650 Form B (industrial standard) for cable plug Type 2507

^{*)} so far DIN 43650

① For port connection G thread F1 and G1 applies; port connection NPT thread F2 and G2; port connection Rc thread F3 and G3.

DN	A	B	C	D	E	F1 ①	G1 ①	F2 ①	G2 ①	F3 ①	G3 ①	L	SW
10	67.5	81.5	32	32	25	14	G1/2	13.7	NPT 1/2	13.2	Rc1/2	55	27
10	67.5	81.5	32	32	25	12	G3/8	10.3	NPT 3/8	10.1	Rc3/8	55	27
13	72	88	40	46	31	16	G3/4	14	NPT 3/4	14.5	Rc3/4	65	32
13	72	88	40	46	31	14	G1/2	13.7	NPT 1/2	13.2	Rc1/2	65	32
20	81	101.5	60	60	50	18	G1	16.8	NPT 1	16.8	Rc1	100	41
20	81	101.5	60	60	50	16	G3/4	14	NPT 3/4	14.5	Rc3/4	100	41

Ordering charts for valves

Type 6211 Solenoid Valve with coil acc. to DIN EN 175301-803¹⁾ Form C for cable plug Type 2506

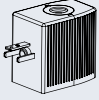
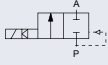
	Circuit function	Orifice DN [mm]	Port connection [NPT]	C _v value water [GPM]	Pressure range [PSI] ¹⁾	Voltage/Frequency [V/Hz]	Item no. Seal NBR	Item no. Seal FKM	Item no. Seal EPDM		
	A	3/8" (DN 10)	NPT 3/8	2.23	7-145	24/VDC	458 502 D	458 510 G	458 494 V		
						24/60	458 503 E	458 511 V	458 495 W		
						120/60	458 504 F	458 512 W	458 496 X		
								240/60	458 505 G	458 513 X	458 497 Y
		1/2" (DN 10)	NPT 1/2	2.23	7-145	24/VDC	458 506 H	458 514 Y	458 498 H		
						24/60	458 507 A	458 515 Z	458 499 A		
						120/60	458 508 K	458 516 S	458 500 P		
								240/60	458 509 L	458 517 T	458 501 C
		1/2" (DN 13)	NPT 1/2	4.23	7-145	24/VDC	458 526 U	458 534 U	458 518 C		
	24/60					458 527 V	458 535 V	458 519 D			
	120/60					458 528 E	458 536 W	458 520 A			
							240/60	458 529 F	458 537 X	458 521 X	
	3/4" (DN 13)	NPT 3/4	4.23	7-145	24/VDC	458 530 C	458 538 G	458 522 Y			
					24/60	458 531 Z	458 539 H	458 523 Z			
					120/60	458 532 S	458 540 N	458 524 S			
							240/60	458 533 T	458 541 B	458 525 T	
	3/4" (DN 20)	NPT 3/4	9.76	7-145	24/VDC	458 550 Q	458 558 L	458 542 C			
					24/60	458 551 D	458 559 M	458 543 D			
					120/60	458 552 E	458 560 J	458 544 E			
							240/60	458 553 F	458 561 F	458 545 F	
	1" (DN 20)	NPT 1	9.76	7-145	24/VDC	458 554 G	458 562 G	458 546 G			
24/60					458 555 H	458 563 H	458 547 H				
120/60					458 556 A	458 564 A	458 548 J				
						240/60	458 557 B	458 565 B	458 549 K		

¹⁾ Pressure rate [PSI]: Overpressure with respect to atmospheric pressure

²⁾ was DIN 43650

Type 6211 Solenoid Valve with coil Form B (industrial standard) for cable plug Type 2507 on request

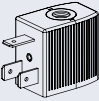
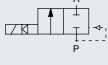
	Circuit function	Orifice DN [mm]	Port connection [NPT]	C _v value water [GPM]	Pressure range [PSI] ¹⁾	Voltage/Frequency [V/Hz]	Item no. Seal NBR	Item no. Seal FKM	Item no. Seal EPDM		
	A	3/8" (DN 10)	NPT 3/8	2.23	7-145	24/VDC	461 688 A	461 700 J	461 675 C		
						24/60	461 689 B	461 701 F	461 676 D		
						120/60	461 690 G	461 702 G	461 677 E		
								240/60	461 691 V	461 703 H	461 678 P
		1/2" (DN 10)	NPT 1/2	2.23	7-145	24/VDC	461 692 W	461 704 A	461 679 Q		
						24/60	461 693 X	461 705 B	461 680 E		
						120/60	461 694 Y	461 706 C	461 681 T		
								240/60	461 695 Z	461 707 D	461 682 U
		1/2" (DN 13)	NPT 1/2	4.23	7-145	24/VDC	461 716 V	461 724 V	461 708 N		
	24/60					461 717 W	461 725 W	461 709 P			
	120/60					461 718 F	461 726 X	461 710 B			
							240/60	461 719 G	461 727 Y	461 711 Y	
	3/4" (DN 13)	NPT 3/4	4.23	7-145	24/VDC	461 720 D	461 728 H	461 712 Z			
					24/60	461 721 S	461 729 A	461 713 S			
					120/60	461 722 T	461 730 F	461 714 T			
							240/60	461 723 U	461 731 U	461 715 U	
	3/4" (DN 20)	NPT 3/4	9.76	7-145	24/VDC	461 740 R	461 748 M	461 732 V			
					24/60	461 741 E	461 749 N	461 733 W			
					120/60	461 742 F	461 750 K	461 734 X			
							240/60	461 743 G	461 751 G	461 735 Y	
	1" (DN 20)	NPT 1	9.76	7-145	24/VDC	461 744 H	461 752 H	461 736 Z			
24/60					461 745 A	461 753 A	461 737 S				
120/60					461 746 B	461 754 B	461 738 B				
						240/60	461 747 C	461 755 C	461 739 C		

¹⁾ Pressure rate [PSI]: Overpressure with respect to atmospheric pressure

- All valves with brass body, different seal materials, **without** cable plug.
- Other versions on request.

Ordering chart for accessories

Cable plug Type 2506 acc. to DIN EN 175301-803³⁾ C

Circuitry	Voltage	Item no.
None (standard)	0 – 250 V AC/DC	008 353 P
with LED	12 – 24 V AC/DC	008 402 A
with LED and varistor	12 – 24 V AC/DC	008 408 Q
with rectifier, LED and varistor	12 – 24 V AC/DC	008 354 Q

- The delivery of a cable plug includes the flat seal and fixing screw.
- Other versions acc. to DIN EN 175301-803³⁾ C see *Datasheet Type 2506*.

Cable plug Type 2507 acc. to DIN 43650 B (industrial standard)



Circuitry	Voltage	Item no.
None (standard)	2 – 250 V AC/DC	423 845 R
with LED	24 V AC/DC	423 849 V
with LED and freewheeling diode	12 – 24 V DC	423 851 P
with rectifier, LED and varistor	12 – 24 V AC/DC	423 853 R

- The delivery of a cable plug includes the flat seal and fixing screw.
- Other versions acc. to DIN 43650 B (industrial standard) see *Datasheet Type 2507*.

ASI cable plug Type 2510 acc. to DIN EN 175301-803³⁾ C

Voltage	Current rating	Item no.
Bus supplied	without	142 693 X
	with	142 692 W
External supply	without	142 689 B
	with	142 688 A

- The delivery of an ASI appliance socket includes the seal and the fixing screw.
- Other versions see *Datasheet Type 2510*.

³⁾ so far DIN 43650