



Type 6144 can be combined with...



Type 6524

Servo-assisted
pneumatic valve



Type 6144

Multiple manifolds
(e.g. 6 valves)

3/2 way Flipper Solenoid Valve, direct acting

- Direct-acting
- 0 to 10 bar
- Low power consumption
- Sub-base connection
- 10 mm width per station
- Standard, EEx ia Version

Type 6144 is a direct-action 3/2 way solenoid valve designed for neutral gases and liquids. Through the movement between the 2 end positions, the switching element (flipper) seals one of the two opposing valve seats and connects the other to the working port. This movement is caused by the solenoids magnetic field pushing a permanent magnet that is fixed to the flipper element. In addition to its exceptional performance characteristics, the flipper principle is especially marked by its very low switching noise and its low wear level. Furthermore, integrated medium separation enables use above and beyond pneumatic applications. Depending on the case of operation, various flange connections are available that are suitable for both individual and block mounting.

Installation advice: The valve must have a minimum distance of 5 mm from other ferromagnetic materials in order to avoid malfunctioning during operating conditions.

Circuit function C

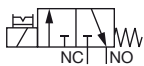

3/2 way direct-acting solenoid valve, normally closed, with manual override

Circuit function D



3/2 way direct-acting solenoid valve, normally open, with manual override







Technical data	
Body material	PPS (Polyphenylensulfide)
Seal material	FKM
Media	Compressed air lubricated, oil-free or dry; neutral gases and liquids (5µm filtering); technical vacuum
Media temperature	- 10 to + 55 °C
Ambient temperature	- 10 to + 55 °C
Port connection	<ul style="list-style-type: none"> ▪ Bürkert flange ▪ Lateral flange ▪ UNF 1/4- 28 ▪ Lateral angle flange ▪ Hose connector
Electrical connection	Rectangular plug as standard; on request: <ul style="list-style-type: none"> ▪ Circular plug M8 x 1 ▪ Flying lead 0.2 mm² ▪ Blank connector (5.08 mm)
Type of protection	without
Standard version	II 2G Ex ia IIC T4 T5 T6 PTB01 ATEX 2048
Ex version	IECEx PTB 07.0063
Operating voltage	24 V DC ¹⁾ 12 V DC ¹⁾ Further voltages on request
Voltage tolerance	± 10 % ²⁾
Nominal power	0.8 W
Switching function	Monostable Bistable (impulse) on request
Duty cycle	100 % continuous rating
Installation	As required, preferably with actuator upright; 5 mm minimum distance to ferromagnetic materials
Insulation class	3 acc. VDE 0580
Protection class	IP40, IP65 for flying leads and round plug (without manual override)
Cycling rate	ca. 1000/min
Electrical control	with SPS possible
Response times	Measurement at the valve outlet, at 20 °C and 6 bar inlet pressure, according to DIN ISO 12238:
Open (Pressure rise 0 to 10 %)	ca. 8 ms (Standard) ca. 14 ms (Ex version)
Close (Pressure rise 100 to 90 %)	ca. 10 ms (Standard) ca. 18 ms (Ex version)

¹⁾ Battery voltage; observe polarity as shown on top of the valve

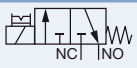
²⁾ Max. allowed ripple

Ordering chart, standard version (other versions on request)

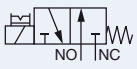

All valves with mounting screws and flange seal; without plug connection (see Accessories)

Circuit function	Port connection	Orifice [mm]	Q_{N_2} value air [l/min] ¹⁾	K_v value water [m ³ /h] ⁴⁾	Pressure range ²⁾ [bar]	Manual override	Voltage [V]	Nominal power [W]	Article no. rectangular plug	Article no. flying leads with 500 mm length
 3/2 way valve NC	Bürkert flange	0.6	8.5	0.0075	0-10 ³⁾	with	12 24	0.8	182862 	215686 
	Lateral flange	0.6	8.5	0.0075	0-10 ³⁾	with	24	0.8	175682 	214196 
 3/2 way valve NO	Bürkert flange	0.6	8.5	0.0075	0-10	with	24	0.8	175653 	■
	Lateral flange		8.5	0.0075					179098 	■

¹⁾ Q_{N_2} value air [l/min]: Measurement with +20 °C, 6 bar pressure on the valve input and 1 bar pressure differential
²⁾ Pressure values [bar]: Measured as overpressure to the atmospheric pressure
³⁾ Application with vacuum on request
⁴⁾ Measured at +20 °C, 1 bar pressure difference, measured as overpressure to the atmospheric pressure

Mounting screws for Bürkert flange: M1.6 × 5 for Lateral flange: M1.6 × 20





i Further versions on request

-  **Electrical connection**
Electrical connection left or right-sided alternatively. Possible electrical connections are 2 single flying leads, M8 × 1 round plugs or plug for contacting circuit board.
-  **Circuit functions**
Circuit function A, B and T
-  **Additional**
On request, the valve can be delivered with a manual override on the left or right side, but also without.

Ordering chart, Ex version

Approval acc. to II 2G Ex ia IIC T4 T5 T6 PTB01 ATEX 2048 and IECx PTB 07.0063

All valves with rectangular plug, mounting screws and flange seal; without plug connection (see Accessories)

Circuit function	Port connection	Orifice [mm]	Q_{N_2} value air [l/min] ¹⁾	K_v value water [m ³ /h] ⁴⁾	Pressure range ²⁾ [bar]	Manual override	Resistance at 20 °C ± 4% [Ω]	Minimum holding current [mA]	Article no.
 3/2 way valve NC	Bürkert Flange	0.6	8.5	0.0075	0-7	yes	320	29	175657 
	Bürkert Flange	0.6	8.5	0.0075	0-7	yes	510	23	175656 
 3/2-Wege-Ventil NO	Bürkert Flange	0.6	8.5	0.0075	0-7	yes	320	29	183550 

¹⁾ Q_{N_2} value air [l/min]: Measurement with +20 °C, 6 bar pressure on the valve input and 1 bar pressure differential
²⁾ Pressure values [bar]: Measured as overpressure to the atmospheric pressure
³⁾ Vacuum up to 10 bar on request
⁴⁾ Measured at +20 °C, 1 bar pressure difference, measured as overpressure to the atmospheric pressure

Mounting screws for Bürkert flange: M1.6 × 5 for Lateral flange: M1.6 × 20

Electrical data:

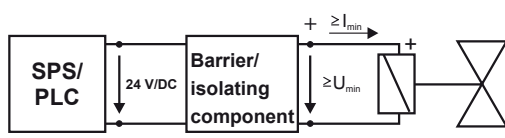

Functional values for valve switching function at 0 °C to +55 °C	Permitted maximum values/ value pairs acc. to operating instructions
Min. holding current: 29mA	U_i 35 V
Nominal coil resistance 320Ω ± 4%	I_i 0.9 A
Min. Holding current: 23mA	
Nominal coil resistance 510Ω ± 4%	

Ordering chart for accessories

Device	Characteristics	Article no.
Bürkert flange		
Single manifold	for Bürkert flange under M3	639873
Manifold 2-fold	for Bürkert flange, M5	641911
Manifold 4-fold	for Bürkert flange, M5	641912
Manifold 6-fold	for Bürkert flange, M5	639874
Blanking plate kit	for multiple manifolds, Bürkert flange	645512
Lateral flange		
Single manifold	for lateral flange, M3	639234
Manifold 2-fold	for lateral flange, M5	641915
Manifold 4-fold	for lateral flange, M5	641916
Manifold 6-fold	for lateral flange, M5	639235
Blanking plate kit	for multiple manifolds, lateral flange	645513
Tube connector plug		
Screw in fitting connection	Brass, straight, for M3 and tube -Ø 4 mm	782534
Screw in fitting connection	Brass, straight, for M5 and tube - Ø 4 mm	787810

Options for the electrical connection, rectangular plug as standard, other connections on request

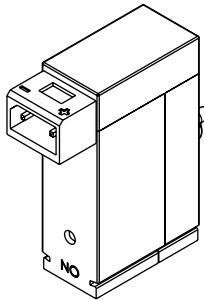

Rectangular plug
Raster 5.08 mm

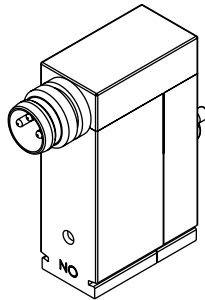

Circular plug
M8 x 1

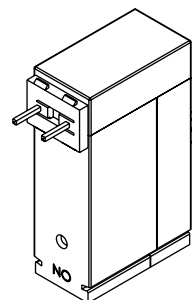

Blank connector
Raster 5.08 mm
(e.g. for board mounted connection 0.63 x 0.63)

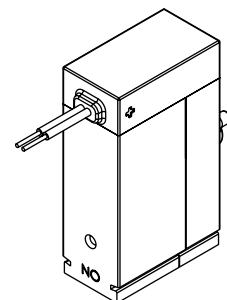

2 flying leads
0.2 mm², 300 mm long

Cable plug, Type 2505

	Type 2505, cable version	Article no.
	with 3 m	133486
	with 5 m	167494
	Type 2505, flying lead version	Article no.
	with 300 mm	644068
	with 600 mm	162144

See also datasheet Type 2505

Dimensions [mm]

Type 6144 with lateral flange

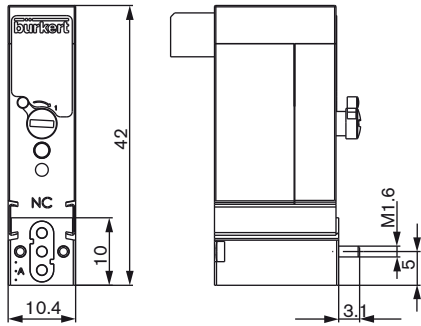

Flange pattern for manifolds with lateral flange

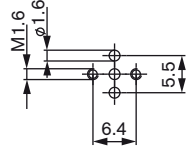

The valve can optionally be delivered with manual override on the left or right hand side (standard: opposite the electrical connection).

Single manifold for lateral flange

Material: Aluminium, M3 threaded

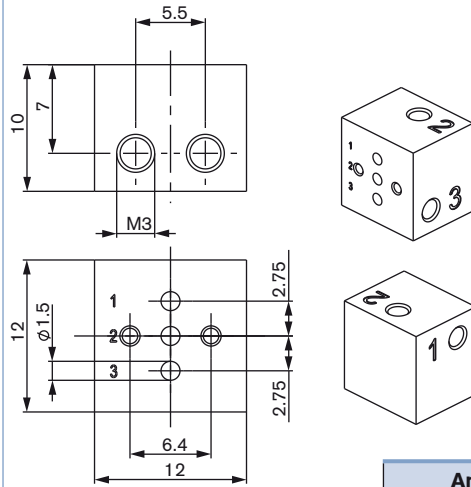

Article no.
639234

Multiple manifolds for lateral flange

Material: Aluminium, M5 threaded

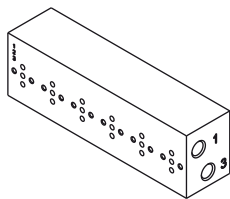
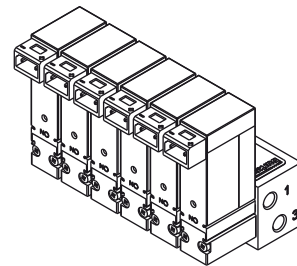
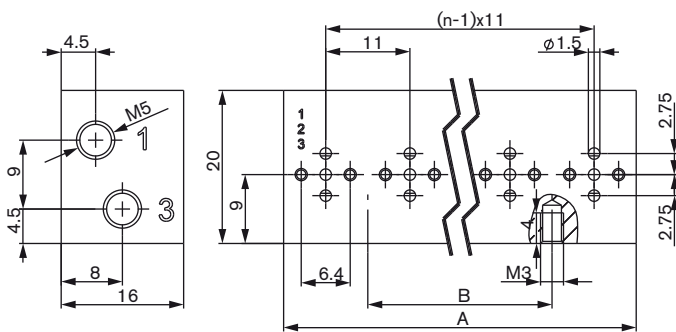

Service ports M5 - 5 deep on the rear side panel

n	A	B	Article no.
2 valves	22	0	641915
4 valves	44	22	641916
6 valves	66	44	639235
8 valves	88	66	672676
Blanking plate kit			645513

Dimensions [mm] (cont.)

Type 6144 with Bürkert flange

Flange pattern for manifolds with Bürkert flange

The valve can optionally be delivered with manual override on the left or right hand side (standard: opposite the electrical connection).

Single manifold for Bürkert flange
Material: Aluminium, M3 threaded

Article no.
639873

Multiple manifolds for Bürkert flange,
Material: Aluminium, M5 threaded

n	A	B	Article no.
2 valves	22	0	641911
4 valves	44	22	641912
6 valves	66	44	639874
Blanking plate kit			645512

Examples

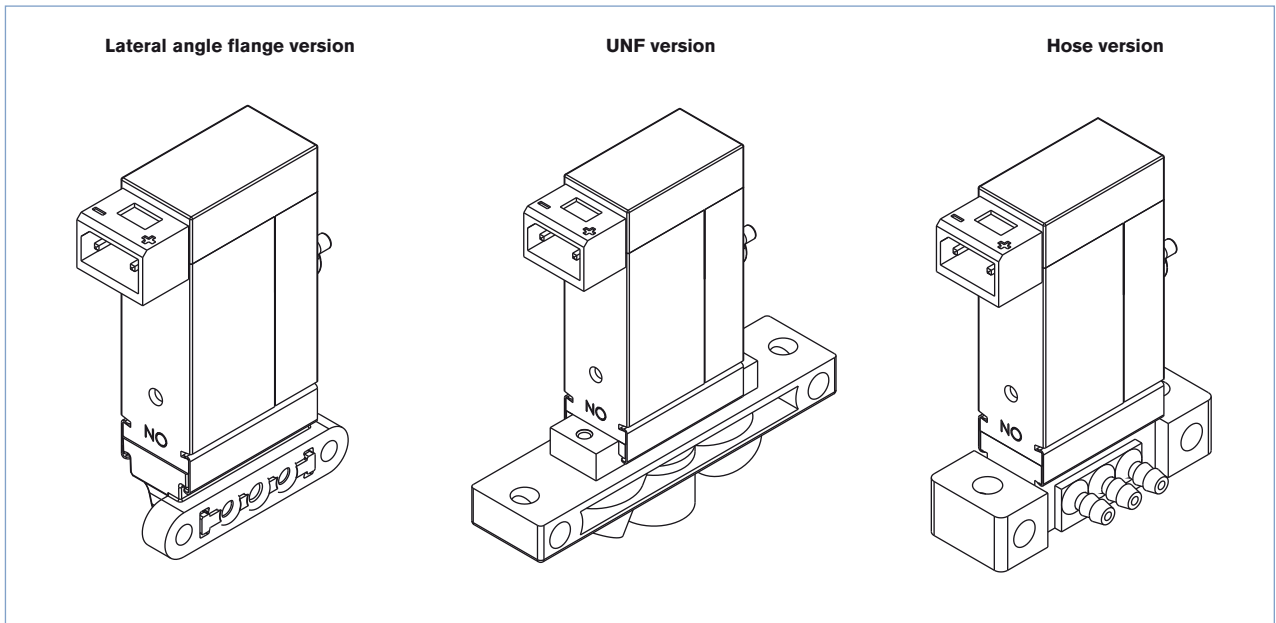

To find your nearest Bürkert facility, click on the orange box →

www.burkert.com

In case of special application conditions,
please consult for advice.

We reserve the right to make technical changes without notice.
© Christian Bürkert GmbH & Co. KG

1801/7_EU-en_00895023