

3/2 and 4/2 multi-way valves; servo assisted;
DN 4; flow rate: 300 l/min.; G 1/8 legris \varnothing 6 mm port connections



Advantages / Benefits

- ▶ Optimal system solutions due to high level of modularity
- ▶ High flow rate at compact design
- ▶ Long service life even with non-lube conditions
- ▶ With manual override
- ▶ Extendable due to modular assembly
- ▶ Various options for the service ports 2 and 4
- ▶ High switch reliability
- ▶ Fieldbus compatible
- ▶ Wide range of cable plugs with circuitry as accessories
- ▶ Low weight

Design/Function

Type 5470 includes high switch reliable diaphragm seat valves as 3/2 and 4/2 way version. The valve consists of three modules, valve body with servo-diaphragm, plungers and seat seal as well as numerous connection possibilities for the service ports 2 and 4.

The body and valve internal parts are made of high quality thermoplastic, the return spring of Stainless Steel.

A 16 mm rocker solenoid valve type 6106 with rectifier is used as pilot. Tag connectors are used as electrical contact (acc. DIN 43 650 Form C) with the cable plug type 2506 or with female connectors on the available valve blocks of Burkert.

The extendable type 5470 can be used for block modules (tag connectors in front) or for entire valve blocks (tag connectors at the back, coil spacing 19 mm).

The available valve block can be controlled by various fieldbus systems, Multipole or common terminals.

The block assembly is made with pneumatic modules type MP05 through integrated lock technology and screwing.

Type 6106 impulse version is a bistable valve used as pilot valve for type 5470. The operation has to be done through external pole reversal (e.g. PLC).

The advantages of the impulse version are functional safety at short time power failure, saving of energy and low heat generation.

It is applicable for switching systems with impulse control.

Applications

Fluids

Lubricated and unlubricated air, neutral gases

Applications

Control valves (single valves, valve blocks) for pneumatic linear and rotary actuators (actuator systems) preferably for

- Food and beverage industry
- General processing industry
- Packing machine manufacturers
- Textile industry
- Machine tool manufacturers
- Wood working machine manufacturers

bürkert
Easy Fluid Control Systems

Technical data type 5470 (Block Assembly)

Circuit Functions

C 3/2 way valve,
when de-energized,
outlet port exhausted

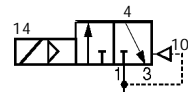

C 3/2 way valve,
with **impulse** at terminal 1
outlet port A exhausted,
with **impulse** at terminal 2
outlet port A pressurized

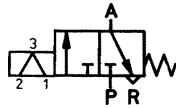

Circuit Functions

D 3/2 way valve,
when de-energized,
port 2 pressurized

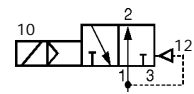

G 4/2 way valve,
when de-energized,
pressure inlet port 1
connected to outlet port 2,
outlet port 4 exhausted

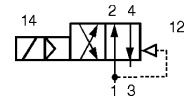

Specifications

Circuit function	Orifice	Flow rate ¹⁾ QNn-value air [l/min]	Pressure range ²⁾ [bar]	Port Connections
C (3/2)	4.0	300	2 - 10	supply ports 1 and 3: sub-base
D (3/2)	4.0	300	2 - 10	service ports 2 and 4: threaded port G 1/8",
G (4/2)	4.0	300	2 - 10	plug-in coupling ø 6 mm or screwed tube connector SL 6/4 mm

¹⁾ Measured with 6 bar upstream pressure and 1 bar pressure drop across the valve at +20 °C.

²⁾ All pressures quoted are gauge pressures with respect to the prevailing atmospheric pressure.

Valve specifications

Body material	PA (Polyamide)
Valve internal parts	PA
Return spring	Stainless Steel
Seal material	NBR
Fluids	Lubricated, unlubricated compressed air, neutral gases
Media temperature	-10 up to +50°C
Ambient temperature	-10 up to +55°C

Response times ³⁾	1 W coil	2/3 W coil
Open (On)	25 ms	15 ms
Close (Off) (without electronics)	20 ms	12 ms
Close (Off) (with electronics) ⁴⁾	30 ms	20 ms

Response times for impulse versions	
Minimum duration of impulse:	
Release coil (tag 1 and 3)	20 ms
Operating coil (tag 2 and 4)	20 ms

Port connections

Connection 1 and 3	Sub-base at the back
Connection 2 and 4	<ul style="list-style-type: none"> G 1/8 in front Plug-in coupling ø 6 mm below or in front Screwed tube connector SL 6/4 mm, in front

Solenoid specifications

Operating voltage	24 V DC 24 V impulse (external pole reversal necessary) 110 - 120 V DC 220 - 240 V DC (for alternating current cable plug type 2506 with rectifier necessary) ⁴⁾
Voltage tolerance	±10 %
Electrical power consumption	1 W, 2 W, 3 W
Duty cycle	100 % continuously rated
Electr. connection	Tag connectors in front or at the back acc. DIN 43 650 Form C, for cable plugs type 2506 (see accessories)
Rating	IP 65 (with cable plug)
Ex-approval	(see data sheet Ex-versions)

Installation

- Preferably on valve blocks
 - Block assembly on MP05 with DIN-rail 50022
- Mounting position: any, but preferably with solenoid system upright

³⁾ Measured at connection 2; time from electrical switching to pressure increase to 90% (opening) or pressure drop to 10% (closing) of operational pressure of 6 bar. The valves given apply for DC and AC.

⁴⁾ When using electronics (diodes for controlling LEDs or for rectifying), the closing time is delayed 8 up to 10 ms.

Dimensions single valve [mm]

3/2 way valves, circuit function C, supply ports 1 and 3 as sub-base, tag connectors in front or at the back ¹⁾

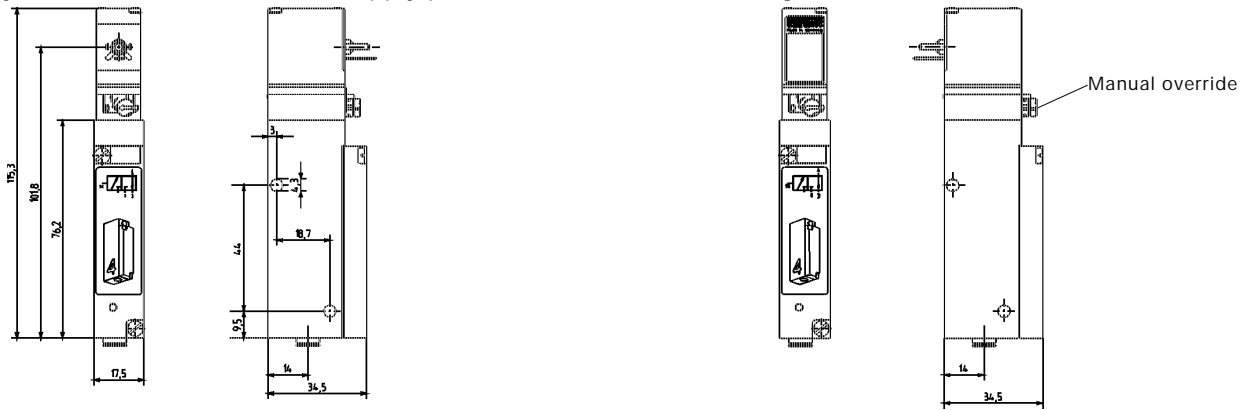

Picture 1: Plug-in coupling \varnothing 6 mm, below, tag connectors in front

Picture 2: Plug-in coupling \varnothing 6 mm, below, tag connectors at the back

4/2 way valves, circuit function G, port connections 1 and 3 as sub-base, tag connectors in front or at the back ¹⁾

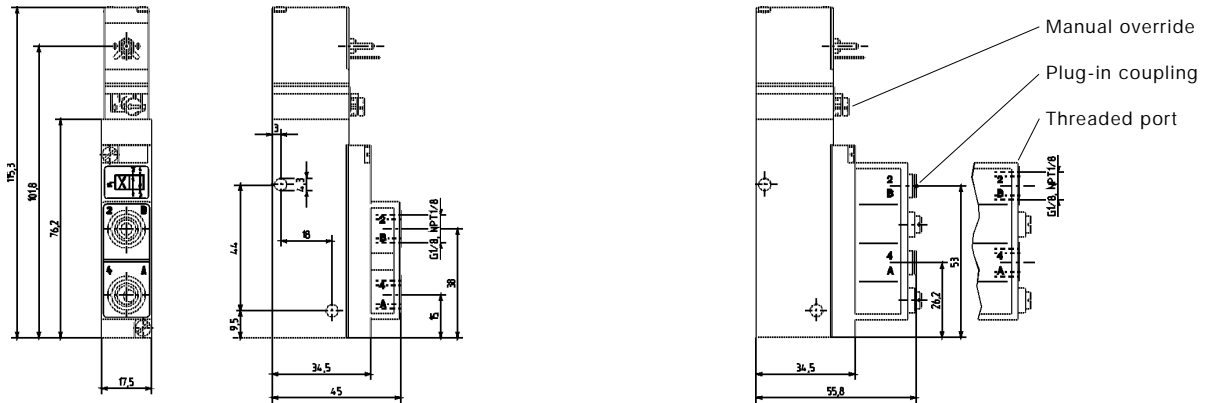

Picture 3: Threaded port G 1/8", in front, tag connectors in front

Picture 4: Plug-in coupling \varnothing 6 mm and threaded port G 1/8", in front, with one-way flow restrictor, tag connectors in front

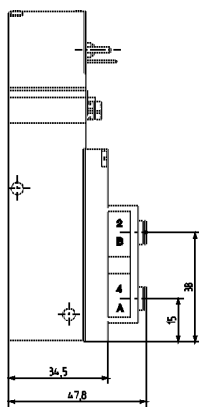

Pict. 5: Plug-in coupling \varnothing 6 mm, in front, tag connectors in front

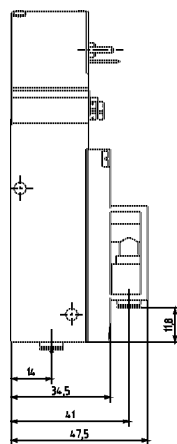

Pict. 6: Plug-in coupling \varnothing 6 mm, below, tag connectors in front

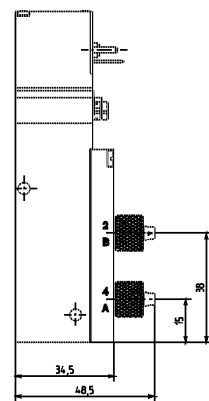

Pict. 7: Screwed tube connector SL 6/4 mm, in front, tag connectors in front

1) Tag connectors **in front**: for block assembly; tag connectors **at the back**: for assembly on valve blocks

All sub-base valves type 5470 are available with tag connectors in front or at the back (see ordering chart)

Dimensions [mm] block and wall mounting with pneumatic modules type MP05

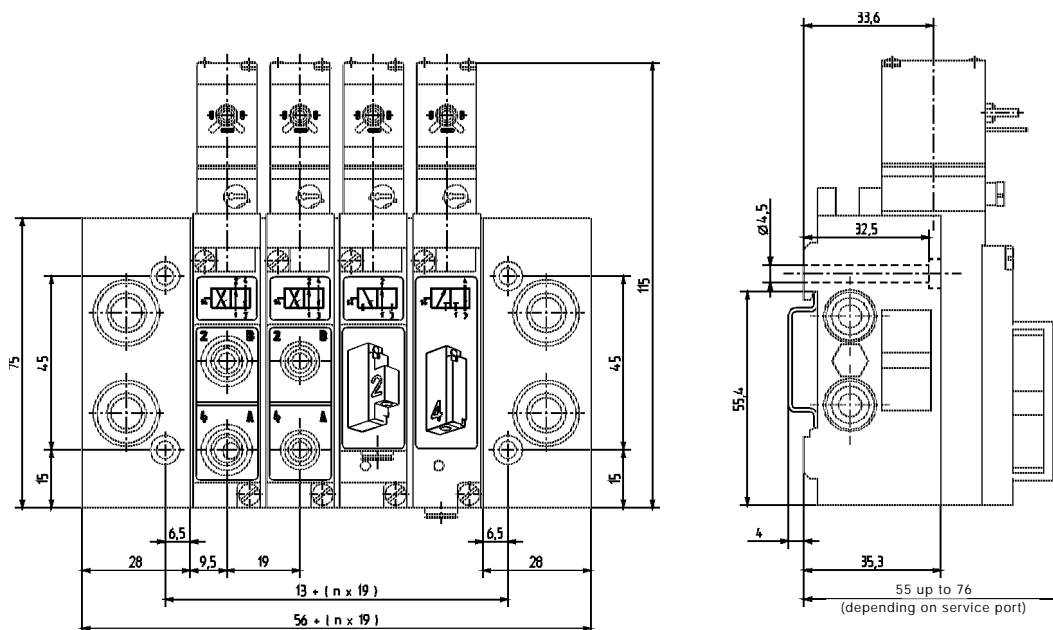

Exploded view of block assembly with pneumatic modules type MP05, coil spacing 19 mm

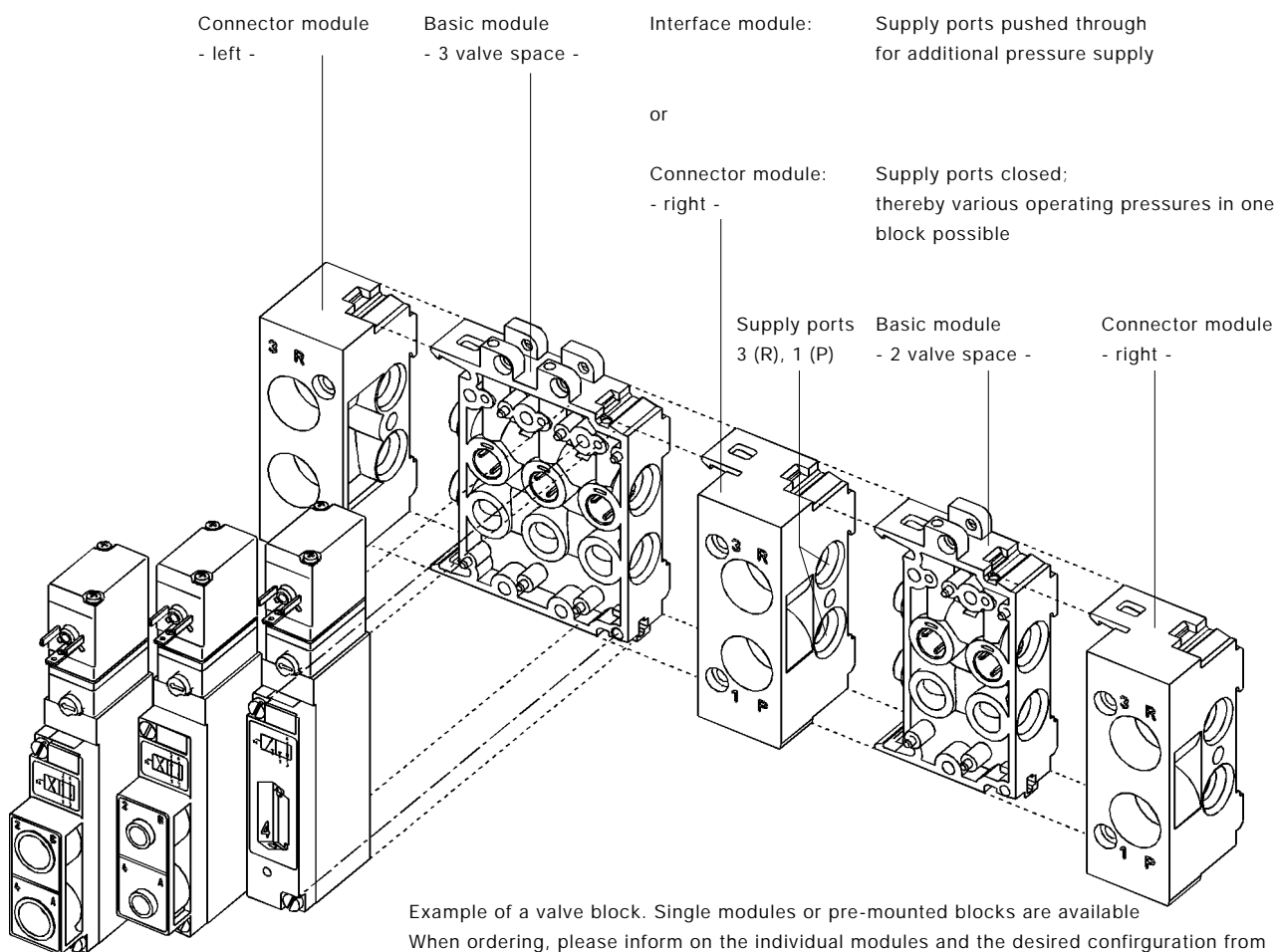

Example of a valve block. Single modules or pre-mounted blocks are available
When ordering, please inform on the individual modules and the desired configuration from right to left.
For information on assembly of a valve block, please see data sheet Customized Pneumatic Systems Solutions.

Ordering chart valves type 5470 (other versions on request)

Scope of delivery: All valves with manual override and with NBR seal; supply ports 1 and 3 as sub-base version; with fixing screws and sub-base seal; tag connectors acc. DIN 43 650 C front or at the back; **without cable plug** (see accessories)

Electr. connection:

- For block assembly with tag connectors in front: **cable plug type 2506** (see accessories)
- For block assembly with tag connectors at the back: **integrated female connectors** on the electrical basic modules of the valve blocks

Circuit function	Orifice	Flow rate Q _{Nn} value air	Pressure range	Port connections	Voltage/frequency	Electrical power consumption	Item No. tag connectors at the back for valve blocks	Item No. tag connectors in front for valve blocks (without cable plug) *)
	[mm]	[l/min]	[bar]	4 and 2	[V/Hz]	[W]		
C	4.0	300	2 - 8	Plug-in coupling ø 6 mm, below (Picture 1 and 2)	024/DC	1	132 479 W	135 203 V
					024/Impulse	1	139 851 S	139 852 T
					024/DC	2	133 148 T	135 204 W
					110-120/DC	3	-	132 952 Q
					220-240/DC	3	-	132 953 R
D	4.0	300	2 - 8	Plug-in coupling ø 6 mm, below (Picture 1 and 2)	024/DC	1	132 481 H	136 742 Z
					024/Impulse	1	139 853 U	139 854 V
					024/DC	2	136 741 Y	136 743 S
					110-120/DC	3	-	136 744 T
					220-240/DC	3	-	136 745 U
G	4.0	300	2 - 8	Plug-in coupling ø 6 mm, in front (Picture 5)	024/DC	1	132 487 F	135 205 X
					024/Impulse	1	139 859 A	139 864 X
					024/DC	2	133 149 U	135 206 Y
					110-120/DC	3	-	132 954 J
					220-240/DC	3	-	132 955 K
G	4.0	300	2 - 8	Plug-in coupling ø 6 mm, below (Picture 6)	024/DC	1	132 489 R	135 207 Z
					024/Impulse	1	139 862 V	139 863 W
					024/DC	2	133 150 Z	135 208 A
					110-120/DC	3	-	132 956 L
					220-240/DC	3	-	132 957 M
G	4.0	300	2 - 8	Plug-in coupling ø 6 mm, in front with one-way flow restrictor (Picture 4)	024/DC	1	132 488 Q	135 209 B
					024/Impulse	1	139 860 F	139 861 U
					024/DC	2	133 151 N	135 210 X
					110-120/DC	3	-	133 152 P
					220-240/DC	3	-	133 153 Q
G	4.0	300	2 - 8	Threaded port G 1/8, in front (Picture 3)	024/DC	1	132 483 B	135 211 L
					024/Impulse	1	139 855 W	139 858 H
					024/DC	2	133 157 L	135 212 M
					110-120/DC	3	-	132 958 W
					220-240/DC	3	-	132 959 X
G	4.0	300	2 - 8	Threaded port G 1/8, in front with one-way flow restrictor (Picture 4)	024/DC	1	132 484 C	135 213 N
					024/Impulse	1	139 856 X	139 857 Y
					024/DC	2	133 159 W	135 214 P
					110-120/DC	3	-	133 160 T
					220-240/DC	3	-	133 161 Q
G	4.0	300	2 - 8	Screwed tube connector SL 6/4 mm, in front (Picture 7)	024/DC	1	133 162 R	135 215 Q
					024/DC	2	133 163 J	135 216 R
					110-120/DC	3	-	133 164 K
					220-240/DC	3	-	133 166 M

*) For AC current the cable plug type 2506 with rectifier must be used, see accessories.

Ordering chart pneumatic modules type MP05

Module version	Item No.	Module version	Item No.
Connector module left, G 1/8	133 175 N	Connector module right, G 1/4	132 514 H
Connector module left, NPT 1/8	133 176 P	Connector module right, NPT 1/4	132 515 A
Connector module left, G 1/4	132 512 F	Basic module 2 valve space	132 516 B
Connector module left, NPT 1/4	132 513 G	Basic module 3 valve space	132 517 C
Connector module right, G 1/8	133 177 Q	Basic module 2 valve space with 1-way flow restrictor	132 518 M
Connector module right, NPT 1/8	133 178 Z	Basic module 3 valve space with 1-way flow restrictor	132 519 N

Ordering chart accessories

Accessory part	Characteristics	Item No.
Cable plug type 2506 1)	without circuit, 0 - 250 V	008 353 P
Cable plug type 2506 1)	with LED, 12 - 24 V	008 402 A
Cable plug type 2506 1)	with LED and varistor, 12 - 24 V	008 408 Q
Cable plug type 2506 1)	with LED, rectifier and varistor, 12 - 24 V	008 354 Q
Cable plug type 2506 1)	with LED, rectifier and varistor, 200 - 240 V	008 356 J
Manifold G 1/8	Intermediate supply	643 019 C
Manifold NPT 1/8	Intermediate supply	643 028 D
Blanking screw	G 1/8	631 019 Y
Blanking screw	G 1/4	631 020 V
Blanking plug for plug-in coupling	ø 6 mm	015 397 J
Pressure rings for plug-in coupling	ø 6 mm	015 401 P
Covering plate (black)	for vacant valve spaces	643 223 D
Indicating tag	64 pieces	623 816 L

¹⁾ With these accessories, only a minimum of possible cable plugs with circuit are being mentioned. For other versions, see data sheet type 2506.
A flat seal and a fixing screw are part of the delivery scope of a cable plug

Operation of impulse versions

- Standard cable plug type 2506 - through external pole reversal (e.g. PLC)
- Cable plug - with internal pole reversal