







### Cable plug DIN EN 175301-803

- Protection class IP65
- With approvals: UR, CSA, VDE
- Easy to install
- Also available with moulded-on cable connection



Product variants described in the data sheet may differ from the product presentation and description.

#### Can be combined with

	<b>Type 6011</b> Plunger valve 2/2 way direct-acting	▶
	<b>Type 6211</b> Diaphragm valve 2/2 way servo-assisted	▶
	<b>Type 6212</b> Diaphragm valve 2/2 way servo-assisted	▶
	<b>Type 6228</b> Diaphragm valve 2/2 way servo-assisted	▶

#### Type description

Plug-in connection for the connection of electrical components according to DIN EN 175301-803 Form C (previously DIN 43650).

## Table of contents

<b>1. General technical data</b>	<b>3</b>
<b>2. Dimensions</b>	<b>3</b>
2.1. Cable plug without cable .....	3
2.2. Cable plug with cable .....	4
<b>3. Device / Process connections</b>	<b>4</b>
3.1. Connection details .....	4
<b>4. Product design and assembly</b>	<b>5</b>
4.1. Product assembly .....	5
<b>5. Ordering information</b>	<b>5</b>
5.1. Bürkert eShop – Easy ordering and quick delivery .....	5
5.2. Bürkert product filter .....	5
5.3. Ordering chart .....	6

DTS 1000326278 EN Version: F Status: RL (released | freigegeben | valide) printed: 27.10.2020

## 1. General technical data

### Product characteristics

#### Materials

Housing	Polyamide
Contacts	Brass
Cable diameter	4.5...6 mm
Operating display	LED, colour yellow
Degree of protection	IP65
Number of poles	2 pin + protective conductor

### Performance data

#### Maximum continuous current

without wiring	6 A
with wiring	1 A or 3 A (see "5.3. Ordering chart" on page 6)

### Electrical data

Nominal voltage	0...250 V (depending on the corresponding version)
Contact resistance	≤10 mΩ

### Product connections

Electrical connection	Screw-type terminals
-----------------------	----------------------

### Environment and installation

#### Temperature range

Plug	-40 °C...+125 °C
Seal	-25 °C...+90 °C

## 2. Dimensions

### 2.1. Cable plug without cable

#### Note:

Device plugs with moulded cable do not require an additional flat seal. The seal is moulded onto the cable head.

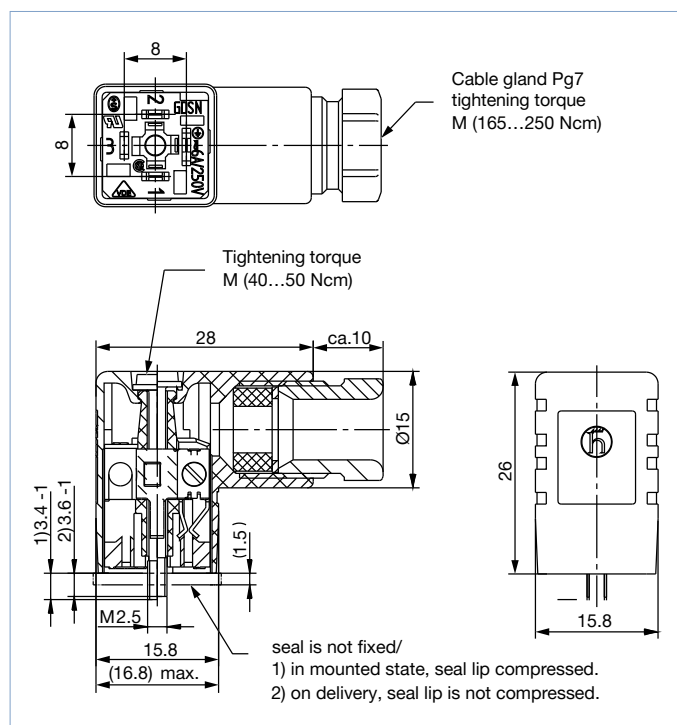

## 2.2. Cable plug with cable

**Note:**

The standard cable length (L) is 3 m. 5 m and 10 m also available on request.

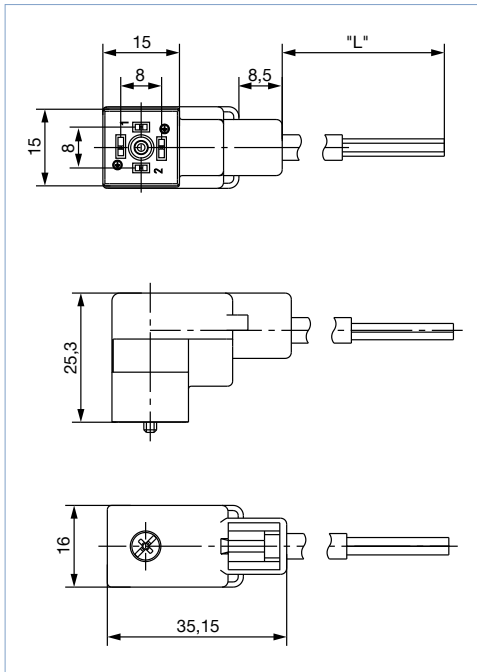

## 3. Device / Process connections

### 3.1. Connection details

Wiring	
<p>Without wiring</p>	<p>With LED</p>
<p>With rectifier, varistor and LED</p>	<p>With LED and varistor</p>

DTS 1000326278 EN Version: F Status: RL (released | freigegeben | validé) printed: 27.10.2020

## 4. Product design and assembly

### 4.1. Product assembly

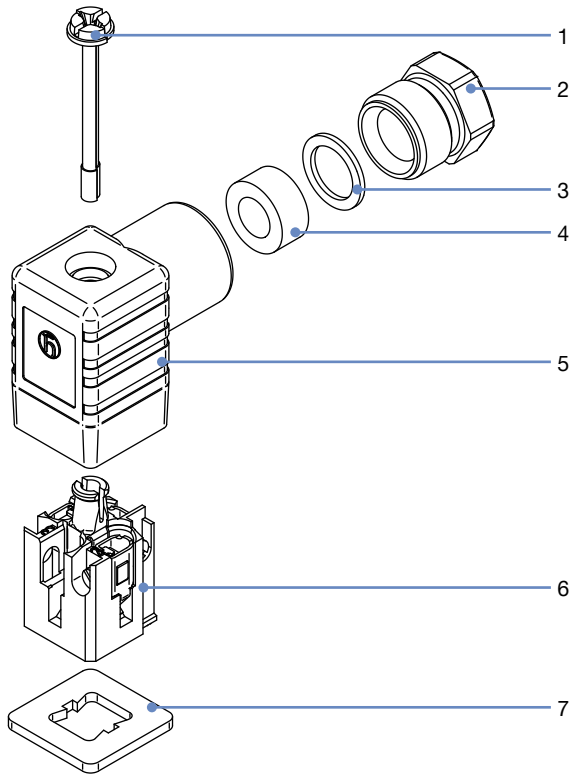

No.	Element
1	M2.5 screw
2	Pressure screw
3	Thrust collar
4	Seal
5	Housing
6	Contact insert
7	Flat seal NBR

## 5. Ordering information

### 5.1. Bürkert eShop – Easy ordering and quick delivery



#### Bürkert eShop – Easy ordering and fast delivery

You want to find your desired Bürkert product or spare part quickly and order directly? Our online shop is available for you 24/7. Sign up and enjoy all the benefits.

[Order online now](#)

### 5.2. Bürkert product filter



#### Bürkert product filter – Get quickly to the right product













You want to select products comfortably based on your technical requirements? Use the Bürkert product filter and find suitable articles for your application quickly and easily.

[Try out our product filter](#)

### 5.3. Ordering chart

**Note:**

Delivery of cable plug includes a flat seal and a fixing screw.

Voltage	Continuous current	Article no. without cable	Article no. with 2 m cable	Article no. with 3 m cable
<b>Without wiring</b>				
0...250 V AC/DC	Max. 6 A	303141 	303161 	-
<b>With LED</b>				
12...24 V AC/DC	Max. 3 A	303145 	303162 	-
100...120 V AC/DC	Max. 3 A	303146 	-	-
200...240 V AC/DC	Max. 3 A	303147 	-	-
<b>With rectifier, varistor and LED</b>				
12...24 V AC/DC	Max. 1 A	-	-	303142 
100...120 V AC/DC	Max. 1 A	-	-	303143 
200...240 V AC/DC	Max. 1 A	-	-	303144 
<b>With LED and varistor</b>				
12...24 V AC/DC	Max. 3 A	303148 	-	-
100...120 V AC/DC	Max. 3 A	303149 	-	-
200...240 V AC/DC	Max. 3 A	303150 	-	-

# Bürkert – Close to You

For up-to-date addresses  
please visit us at  
[www.burkert.com](http://www.burkert.com)

DTS 1000326278 EN Version: F Status: RL (released | freigegeben | validé) printed: 27.10.2020

