

Cable Plug according to DIN EN 175301-803, Form A

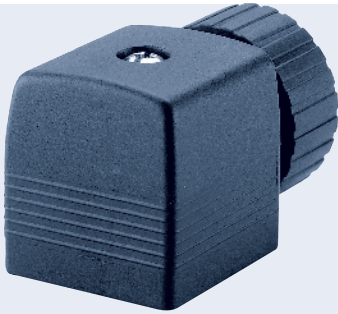

- Complete program
- Contact form 18 mm
- Also available with LED indicator
- Optional 4-pin version for pressure switches resp impulse valves

DTS 1000082421 EN Version: B Status: RL (released | freigegeben | validé) printed: 10.01.2018

Plug for the connection of electrical components according to DIN EN 175301-803 (previously DIN 43650, Form A).

Technical data	
Body material	Polyamide, Polycarbonate (version with LED)
Contact material	Brass, electro-silver-plated
Max. continuous temperature	194°F (+90°C)
Cable diameter	6 - 7 mm (other diameter on request)
Cable outlet	Can be rotated through 4 x 90°
Contact clearance	18 mm according to DIN EN 175301-803 (previously DIN 43650, Form A)
Functional display	LED, colour red (optional)
Electrical connection	Terminal screws max. 1.5 mm ²
Nominal voltage	0 to 250 V
Contact resistance	5 mΩ (typ.)
Protection class	IP 65
Number of terminals	
Standard	2 pins + protective earth
Option	3 pins + protective earth

Ordering chart

The delivery of a cable plug includes the flat seal and the fixing screw (thick-film passivated): In the case of stainless steel valves, we recommend a cable plug with a stainless steel screw (see ordering chart, without circuitry)

Without circuitry, 2 pins + protective earth

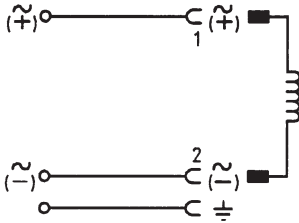

Voltage and version	Current rating	Item no. without cable	Item no. 1m cable	Item no. 3m cable
0 to 250 V/AC/DC with mounting screw	max. 6 A	008 376	783 590	783 573
0 to 250 V/AC/DC with stainless steel screw	max. 6 A	132 445	-	-

Without circuitry, 3-pins + protective earth

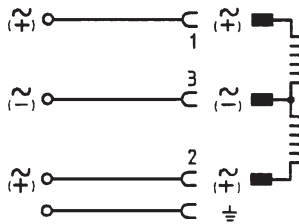

Voltage	Current rating	Item no. without cable	Item no. 1m cable	Item no. 3m cable
0 to 250 V/AC/DC	max. 6 A	008 526	-	-

With LED

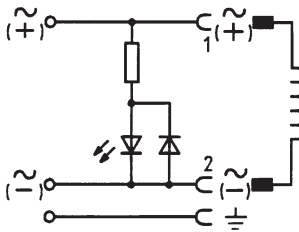

Voltage	Current rating	Item no. without cable	Item no. 1m cable	Item no. 3m cable
12 to 24 V/AC/DC	max. 6 A	008 360	783 574	783 575
100 to 120 V/AC/DC	max. 6 A	008 361	-	-
200 to 240 V/AC/DC	max. 6 A	008 362	783 576	783 577

With rectifier, varistor and LED ¹⁾

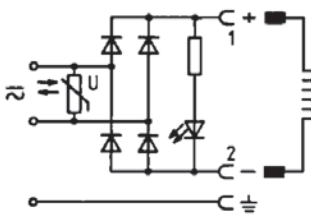

Voltage	Current rating	Item no. without cable	Item no. 1m cable	Item no. 3m cable
12 to 24 V/AC/DC	max. 1 A	008 363	-	-
100 to 120 V/AC/DC	max. 1 A	008 365	-	-
200 to 240 V/AC/DC	max. 1 A	008 366	-	-

¹⁾ With DC, ensure correct polarity

Ordering chart

The delivery of a cable plug includes the flat seal and fixing screw.

With LED and varistor

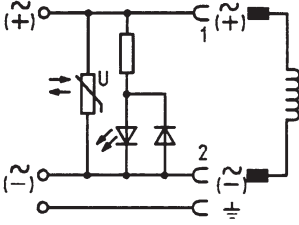

Voltage	Current rating	Item no. without cable	Item no. 1m cable	Item no. 3m cable
12 to 24 V/AC/DC	max. 6 A	008 367	783 578	783 579
100 to 120 V/AC/DC	max. 6 A	008 368	783 580	783 581
200 to 240 V/AC/DC	max. 6 A	008 369	783 582	783 583

With varistor

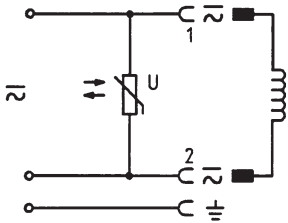

Voltage	Current rating	Item no. without cable	Item no. 1m cable	Item no. 3m cable
12 to 24 V/AC/DC	max. 6 A	008 370	783 584	783 585
100 to 240 V/AC/DC	max. 6 A	008 372	-	-

With pole protection, free wheeling diode and LED

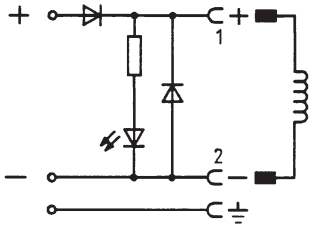

Voltage	Current rating	Item no. without cable	Item no. 1m cable	Item no. 3m cable
12 to 24 V/DC	max. 1 A	008 373	783 586	783 587

With pole protection and free wheeling diode

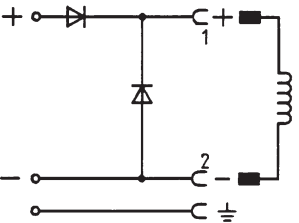

Voltage	Current rating	Item no. without cable	Item no. 1m cable	Item no. 3m cable
12 to 240 V/DC	max. 1 A	008 375	783 588	783 589

With rectifier and varistor

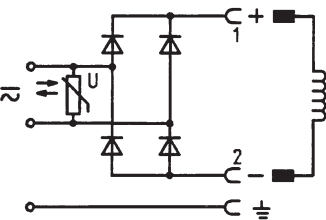

Voltage	Current rating	Item no. without cable	Item no. 1m cable	Item no. 3m cable
12 to 240 V/AC/DC	max. 1 A	008 374	-	-

Note: For cable plug with ASI or high-capacity electronic please see datasheet for Type 2511.

i Further versions on request



Materials

EPDM or silicone gasket



Additional

Versions with 1 or 3 m cable

Other cable diameter

With blue coloured union nut for intrinsically safe solenoid valves

Connector for aggressive ambient with polypropylene

Installation

with LED

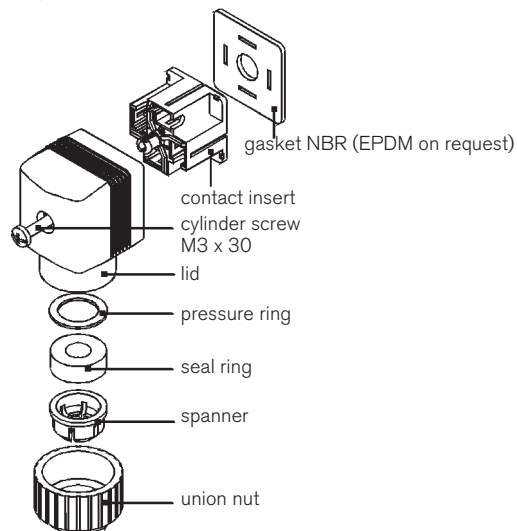

other versions

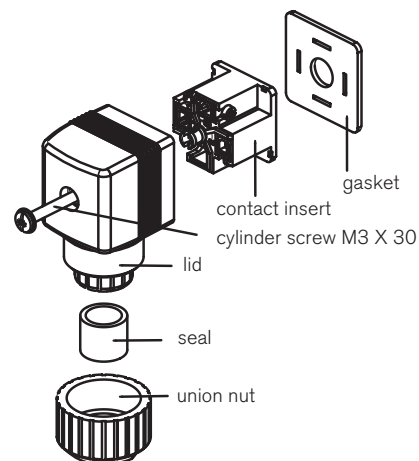

- remove contact insert from lid
- insert cable through union nut
- wire cable according to connection plan
- replace contact insert
- screw-on union nut
- push gasket on tag connectors
- push cable plug firmly onto tags
- secure with tallow-drop screw M3 x 30

Dimensions [mm]

