

Cable Plug acc. to DIN EN 175301 - 803, Form A

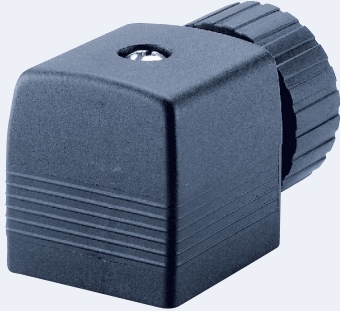

- Complete program
- Contact form 18 mm
- Also available with LED indicator
- Optional 4 pin version for pressure switch or impulse valves respectively
- Versions with high-power, power reduction and inverter for impulse valves

Plug for the connection of electrical components according to DIN EN 175301 - 803 (previously DIN 43650, Form A).

Standard version without circuit, with LED, varistor, rectifier, pole protection- or/and free-wheeling diode.

Variants with HL-circuit to increase performance of solenoid valves, LR-circuit to decrease power consumption and IN-circuit for control of impulse coils.

Technical data	
Body material	Polyamide, polycarbonate (version with LED)
Contact material	Brass, silver-plated
Max. continuous temperature	+ 90 °C (- 10 ... + 55 °C by version HL, LR and IN)
Cable diameter	6 - 7 mm (other diameter on request)
Cable outlet	Can be rotated through 4 × 90°
Contact distance	18 mm according to DIN EN 175301 - 803 (previously DIN 43650, Form A)
Functional display	LED, colour red (optional), yellow with version HL and LR
Electrical connection	Screw terminal Max. 1.5 mm ²
Nominal voltage	Depending on version
Contact resistance	5 mΩ (typ.)
Protection class	IP65
Number of terminals	
Standard	2 pins + protective earth conductor
Option	3 pins + protective earth conductor

Ordering chart

The delivery of a cable plug includes the flat seal and the steel fixing screw (thick-film-passivated); in the case of stainless steel valves we recommend a cable plug with a stainless steel screw (see ordering chart without circuit, or on request)

without circuit

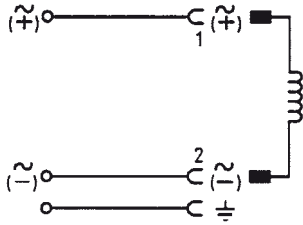

Voltage and version type	Current rating	Article no. without cable	Article no. 1 m cable	Article no. 3 m cable
0 to 250 V AC/DC with steel screw	max. 6 A	008376	783590	783573
0 to 250 V AC/DC with stainless steel screw	max. 6 A	132445	-	-

without circuit, 3-pins + protective earth conductor

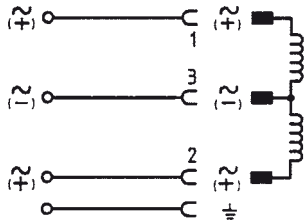

Voltage	Current rating	Article no. without cable	Article no. 1 m cable	Article no. 3 m cable
0 to 250 V AC/DC	max. 6 A	008526	-	-

with LED

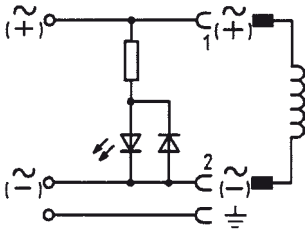

Voltage	Current rating	Article no. without cable	Article no. 1 m cable	Article no. 3 m cable
12 to 24 V AC/DC	max. 6 A	008360	783574	783575
100 to 120 V AC/DC	max. 6 A	008361	-	-
200 to 240 V AC/DC	max. 6 A	008362	783576	783577

with rectifier, LED and varistor

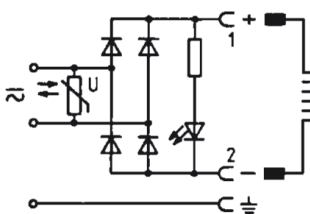

Voltage	Current rating	Article no. without cable	Article no. 1 m cable	Article no. 3 m cable
12 to 24 V AC/DC	max. 1 A	008363	-	-
100 to 120 V AC/DC	max. 1 A	008365	-	-
200 to 240 V AC/DC	max. 1 A	008366	-	-

Ordering chart

Included in delivery is a connector with flat seal and fixing screw.

with LED and varistor

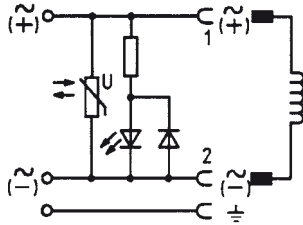

Voltage	Current rating	Article no. without cable	Article no. 1 m cable	Article no. 3 m cable
12 to 24 V AC/DC	max. 6 A	008367	783578	783579
100 to 120 V AC/DC	max. 6 A	008368	783580	783581
200 to 240 V AC/DC	max. 6 A	008369	783582	783583

with varistor

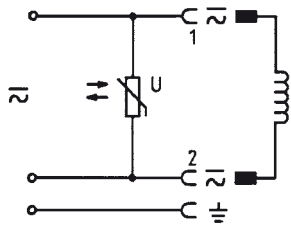

Voltage	Current rating	Article no. without cable	Article no. 1 m cable	Article no. 3 m cable
12 to 24 V AC/DC	max. 6 A	008370	783584	783585
100 to 240 V AC/DC	max. 6 A	008372	-	-

with pole protection, free wheeling diode and LED

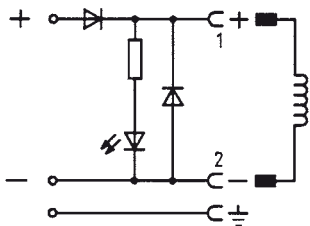

Voltage	Current rating	Article no. without cable	Article no. 1 m cable	Article no. 3 m cable
12 to 24 V DC	max. 1 A	008373	783586	783587

with pole protection and free wheeling diode

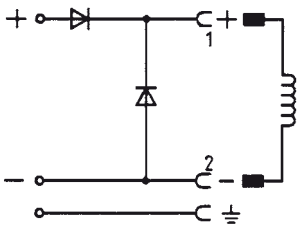

Voltage	Current rating	Article no. without cable	Article no. 1 m cable	Article no. 3 m cable
12 to 240 V DC	max. 1 A	008375	783588	783589

with rectifier and varistor

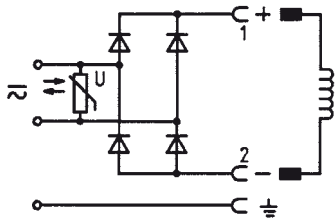

Voltage	Current rating	Article no. without cable	Article no. 1 m cable	Article no. 3 m cable
12 to 240 V AC/DC	max. 1 A	008374	-	-

Note: For cable plug with ASI, or high power electronic for AC, please see datasheet for Type 2511.

Ordering chart

The delivery of a cable plug includes the flat seal and the steel fixing screw (thick-film-passivated); in the case of stainless steel valves a cable plug with a stainless steel screw is recommended (on request).

With high power electronics Type 2508 HL

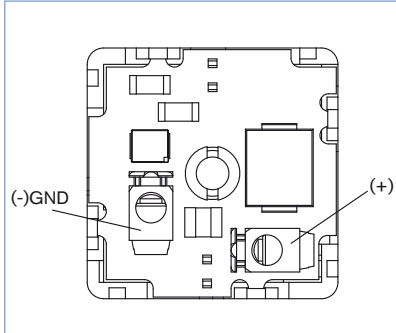

The high power electronics Type 2508HL increases the output of single solenoid valves. The high inrush power is generated by overexcitation. The adjustable pressure can be thus considerably extended. After switching the valve the electronic decreases to a small holding capacity. Also thereby power absorption and coil temperature in continuous operation can be much reduced. In holding operation the function is displayed by a yellow LED.

Suitable solenoid coils must be used for the respective valve supply voltage. Please contact your nearest Bürkert Sales Office for more information.

Technical data		Article no.
Operating voltage U_{nom}	12 - 24 V DC Supply voltage acc. to IEC 364 - 4 - 41 (PELV)	212510
Max. current	3 A (inrush), 0.2 A (holding operation)	
Inrush power ($4xP_{nom}$) depending on valve	max. 72 W at 24 V (36 W at 12 V)	
Nom. holding current ($1/4xP_{nom}$) depending on valve	max. 4.5 W at 24 V (2.25 W at 12 V)	
Pull-in time	approx. 350 ms	
Max. duty cycle ED	10/min	
OFF-Time t_{off} between two switching operations	min. 1 sec.	

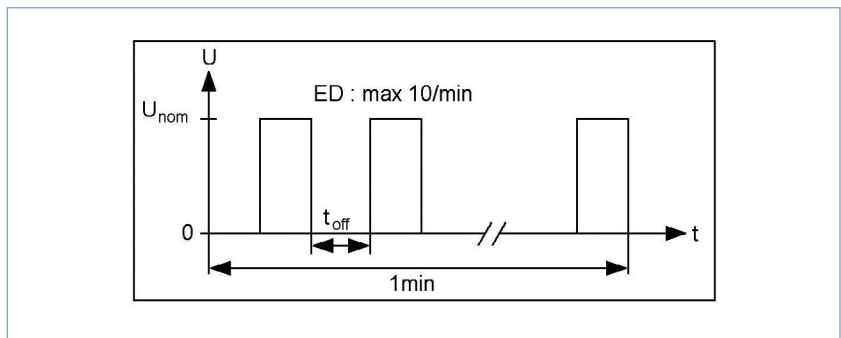

With power reduction Type 2508 LR

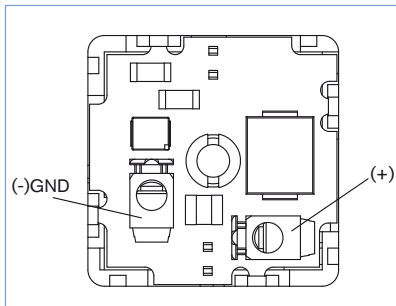

The electronics Type 2508 LR is used for power reduction of solenoid valves. Therewith the power consumption and the coil temperature can be reduced considerably e.g. with continuous operation. The inrush power conforms at this juncture to the nominal power of the coil. After switching the valve the electronic decreases to a small holding capacity. In holding operation the function is displayed by a yellow LED.

Technical data		Article no.
Operating voltage U_{nom}	12 - 24 V DC Supply voltage acc. to IEC 364 - 4 - 41 (PELV)	212511
Max. current	1.5 A (inrush), 0.4 A (holding operation)	
Inrush power (P_{nom}) depending on valve	max. 36 W at 24 V (18 W at 12 V)	
Nom. holding current ($1/4xP_{nom}$) depending on valve	max. 9 W at 24 V (4.5 W at 12 V)	
Pull-in time	approx. 350 ms	
Max. duty cycle ED	10/min	
OFF-Time t_{off} between two switching operations	min. 1 sec.	

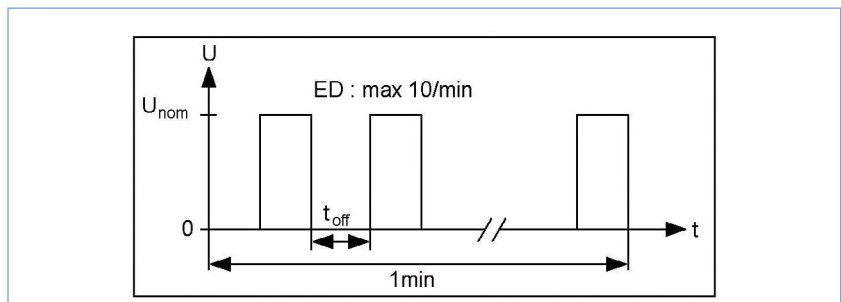

Ordering chart

The delivery of a cable plug includes the flat seal and the steel fixing screw (thick-film-passivated); in the case of stainless steel valves a cable plug with a stainless steel screw is recommended (on request).

With inverter electronics Type 2508 IN

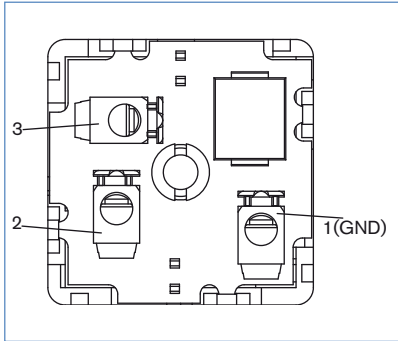

Technical data		Article no.
Operating voltage U_{nom}	6-24 V DC	212512
	Supply voltage acc. to IEC 364-4-41 (PELV)	
Max. coil current	0.6 A (100% ED); 1.2 A (50% ED);	
Max. impulse length	300 ms (at >0.6 A)	

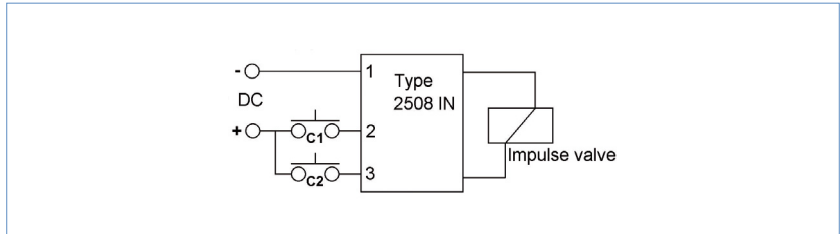

The inverter electronics Type 2508 IN is used to control impulse valves with reverse polarity control by means of 3 control signals (ON, OFF and GND). The switching occurs by reversing the polarity of the valve supply voltage.

Please contact your nearest Bürkert sales office with regard to suitable magnetic coils.

1	2	3	PIN1	PIN2
GND	+ DC	-	+ DC	GND
GND	-	+ DC	GND	+ DC
GND	+ DC	+ DC	+ DC	+ DC
GND	-	-	-	-

i Further versions on request



Material

with EPDM or Silikon flat seal



Additional

Versions with 1 or 3 m cable

For other cable diameter

With blue coloured union nut for intrinsically safe solenoid valves

Connector for aggressive ambient with polypropylene

Mounting Instructions

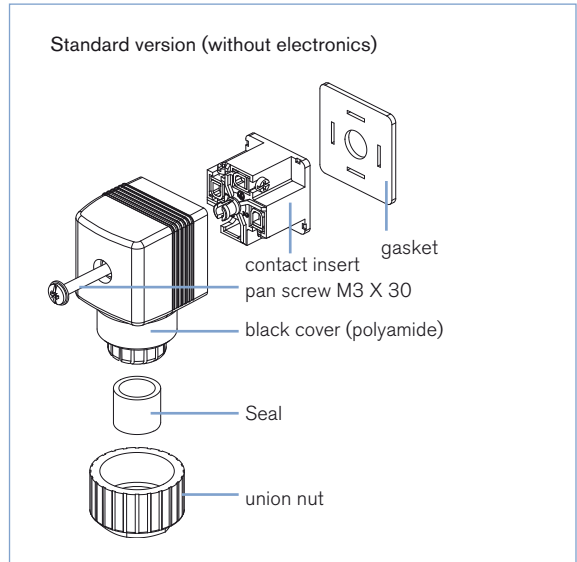
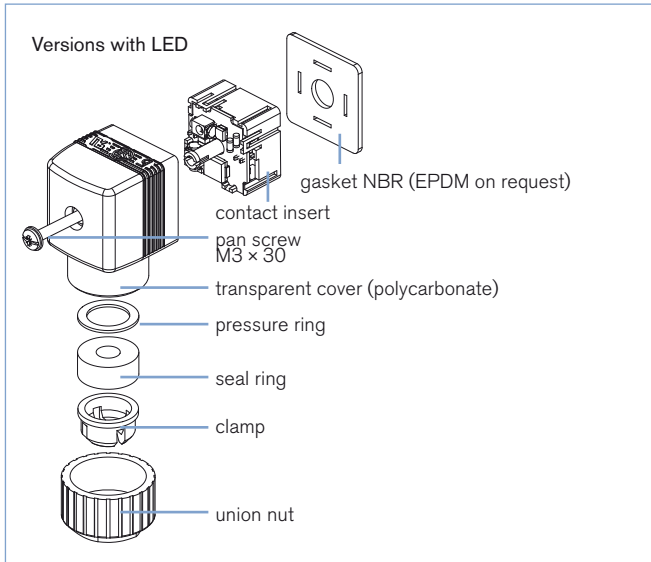

- remove contact insert from cover
- insert cable through union nut
- wire cable according to connection plan
- replace contact insert
- screw-on union nut
- push gasket on tag connectors
- push cable plug firmly onto tags
- secure with pan screw M3 x 30

Dimensions [mm]

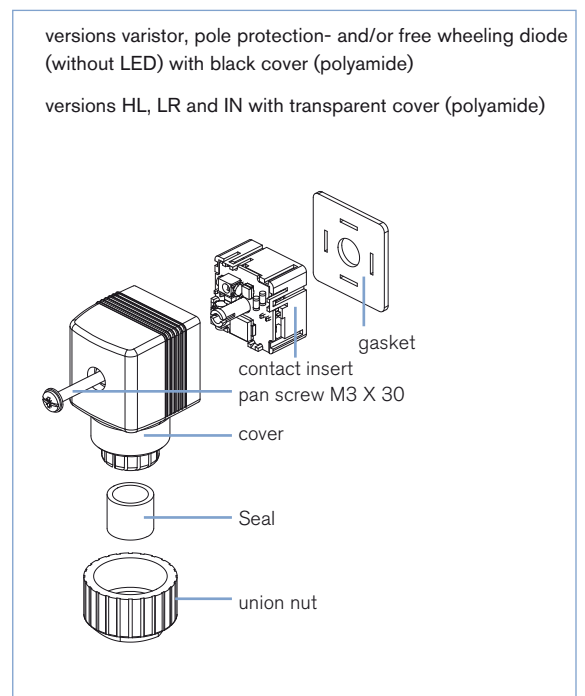
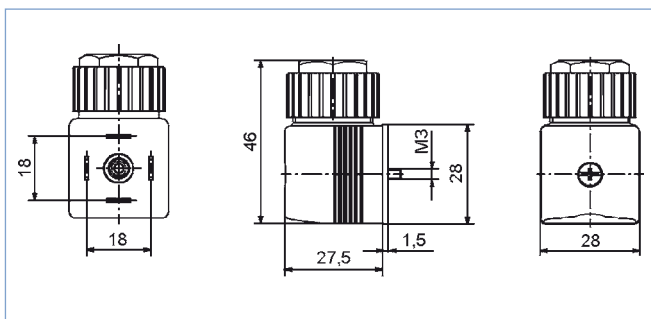

To find your nearest Bürkert facility, click on the orange box →

www.burkert.com

In case of special application conditions,
please consult for advice.

Subject to alterations
© Christian Bürkert GmbH & Co. KG

1801/8_EU-en_00891684