



G 1/4



## Advantages/Benefits

- ▶ EEx ed IIC T4
- ▶ Body material: brass, stainless steel
- ▶ Metal-sealed pressurized parts
- ▶ Push-over coil
- ▶ High sealing capacity, even with large temperature fluctuations

## Design/Function

Type 744 is a direct-acting plunger-type solenoid valve, normally closed by spring action (circuit function C), or normally open by spring action (circuit function D).

When energized, the solenoid armature is drawn against a spring.

The flow path through the valve is dependent upon the chosen circuit function.

Single-phase bridge and varistor are housed in a flameproof enclosure to protection classification "d".

Coil and terminal box correspond to protection classification "e", i.e. increased safety.

The solenoid epoxy encapsulation efficiently dissipates the heat generated by the coil.

## Applications

- Valve to control pneumatic cylinders or rotary actuators
- Handling systems in hazardous areas
- Separators
- Analytical devices
- Offshore-technology
- Petrochemical
- Dosing and mixing systems
- Vacuum



## Technical Data

**Circuit Function** (The circuit functions A, B, D, E or F are developed from the valve in circuit function C by interchanging or plugging the connections.)

**C** 3/2-way valve, when de-energized, outlet A exhausted.

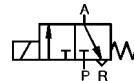

**A** 2/2-way valve, normally closed.

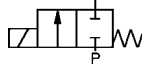

**B** 2/2-way valve, normally open.

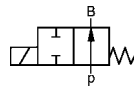

**D** 3/2-way valve, when de-energized, outlet B pressurized.

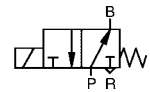

**E** Mixer valve, when de-energized, pressure port P<sub>2</sub> open, P<sub>1</sub> closed.

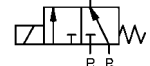

**F** 3/2-way distributor valve, when de-energized, pressure port P connected to outlet B.

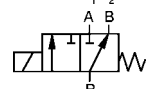

## Body Material

Brass, seat 1.4305 or 1.4410 (stainless steel)

Valve internals 1.4105, 14303

PTB-No. Ex-88.B.1049

## Specifications

Orifice DN	Kv-Value Water	QNm-Value Air	Pressure Range <sup>1)</sup>		Weight
			Circuit Function C		
[mm]	[m <sup>3</sup> /h]	[l/min]	Gas [bar]	Liquid [bar]	[kg]
2	0,11	120	0-16	0-12	0,9
3	0,20	200	0- 7	0- 2,5	0,9
4	0,40	320	0- 3,5	0- 1	0,9

<sup>1)</sup> Also suitable for technical vacuum.

All pressures quoted are gauge pressures with respect to the prevailing atmospheric pressure.

## Operating Data (Valve)

### Seal Materials / Fluids Handled / Temp.-Range

**NBR** Neutral fluids, e.g. compressed air, water, hydraulic oil, oils and fat without additives, town gas  
-10 to +90 °C

**FPM** Hot air, oxygen, per-solutions, hot oils, oils with additives.  
-10 to +90 °C

For more detailed information please refer to resistance chart (Leaflet-No. 1896009).

Max. ambient temperature +40°C

Max. viscosity 21 mm<sup>2</sup>/s

Port connection G 1/4

Response times opening approx. 80 ms  
closing approx. 80 ms

Times measured at outlet A or B from switching on until pressure rise to 90 % / pressure drops to 10 % at a max. working pressure of 6 bar.

## Operating Data (Actuator)

Operating voltages 24, 110, 220, 240 V/UC  
(universal current)

A bridge rectifier has been incorporated in the solenoid system, which makes it suitable for both direct and alternating current. (universal current to DIN 40700).

Voltage tolerance ±10 %

Power consumption 10 W

Rating IP 65



## Installation / Accessories

Installation	as required, but preferably with solenoid system upright	Safety fuse	A safety fuse with a medium response time and rated according to the nominal current should be incorporated in the circuit.
Electrical connection	<ul style="list-style-type: none"> <li>moulded-in cable HO5RN-F3 G, 3x 0,75 mm<sup>2</sup>, length 3 m, with tension relieving cable gland</li> <li>junction box on request</li> </ul>		

## Valve Used as Different Circuit Functions

If used for another circuit function, the recommended operating pressures will vary according to the following chart:

Valve Version	Orifice [mm]	Circuit Function	Max. operating pressure [bar] used in circuit function					
			A	B	C	D	E	F
	2	C	16	25	16	2	2	25
	3	C	7	11	7	1	1	11
	4	C	3,5	6	3,5	0,5	0,5	6

## Dimensions in mm

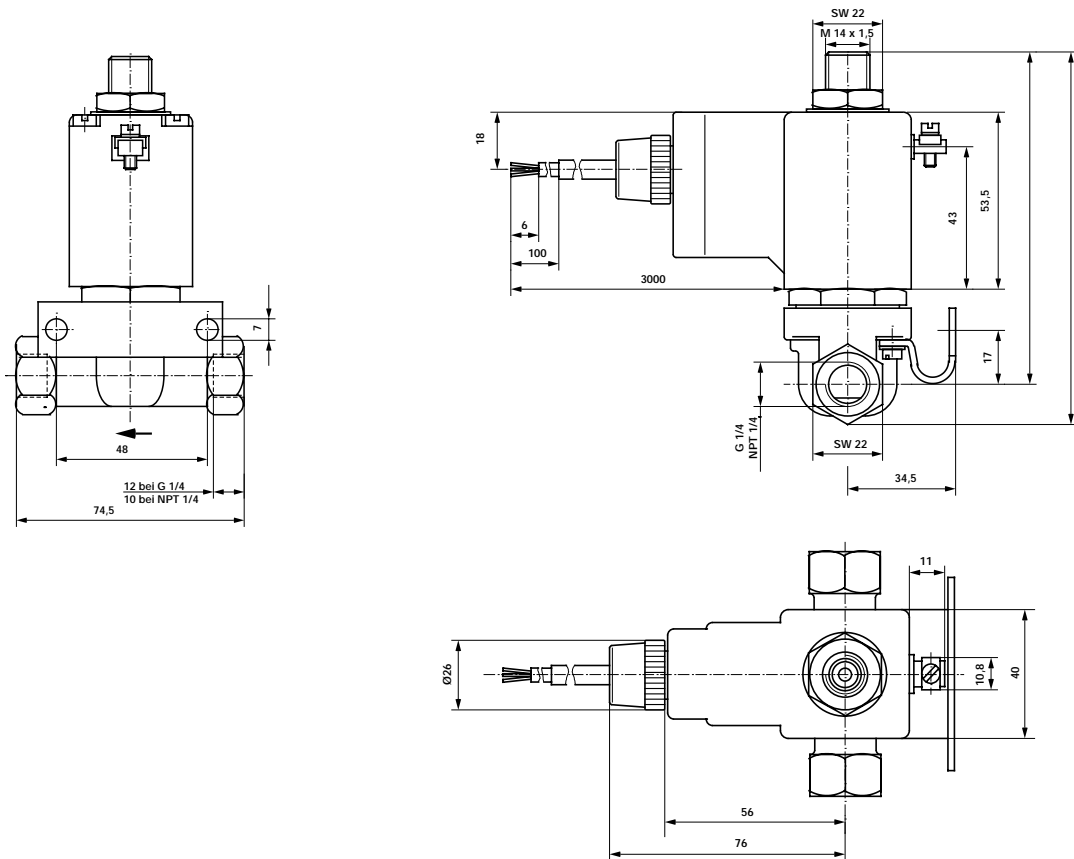

DTS 1000010946 EN Version: A Status: RL (released | freigegeben | valide) printed: 22.09.2017



## Ordering Chart (Other Versions on Request)

Circuit Function	Orifice DN [mm]	Flow Rate		Port Connection (ISO 228)	Pressure Range $\Delta$ [bar]	Body Material	Seal Material	Weight [kg]	Voltage/ Frequency [V/Hz]	Order-No.
		Water Kv-Value [m <sup>3</sup> /h]	Air <sup>1)</sup> Qn [l/min]							
C	2,0	0,11	100	G 1/4	0-16	Brass	NBR	0,9	024/UC	089 481 J <sup>2)</sup>
									110/UC	089 482 K <sup>2)</sup>
									220/UC	089 483 L <sup>2)</sup>
									240/UC	089 484 M <sup>2)</sup>
									024/UC	076 334 X
									110/UC	076 335 Y
	220/UC	076 336 Z								
	240/UC	076 337 S								
	3,0	0,20	200	G 1/4	0- 7	Brass	NBR	0,9	024/UC	089 489 S <sup>2)</sup>
									110/UC	089 490 X <sup>2)</sup>
									220/UC	086 766 T <sup>2)</sup>
									240/UC	089 491 L <sup>2)</sup>
024/UC									076 339 C	
110/UC									076 340 R	
220/UC	076 341 E									
240/UC	076 338 B									
4,0	0,40	400	G 1/4	0- 3,5	Brass	NBR	0,9	024/UC	089 496 R <sup>2)</sup>	
								110/UC	089 497 J <sup>2)</sup>	
								220/UC	089 498 T <sup>2)</sup>	
								240/UC	089 499 U <sup>2)</sup>	
								024/UC	076 342 F	
								110/UC	076 343 G	
220/UC	076 344 H									
240/UC	076 345 A									

<sup>1)</sup> Also suitable for technical vacuum, <sup>2)</sup> Without mounting brackets.  $\Delta$  Lower pressure range for liquids (see specification chart on page 2).

## Order-No. for Accessories

Safety Fuses	[mA]	Order-No.
24 V	1000	007 077 V
110 V	315	007 055 X
220/240 V	160	007 070 A

DTS 1000010946 EN Version: A Status: RL (released | freigegeben | validé) printed: 22.09.2017