



3/2-way Solenoid Valve for neutral medium

- Direct acting
- With hermetic isolation of fluid
- With manual override
- Universal functions
- Electrical feedback optional

Type 0323 can be combined with...



Type 2508

Cable plug



Type 1078

Timer control

The direct acting 3/2-way valve Type 0323 is available in different circuit functions. The solenoid actuator is separated by a double PTFE/ FKM seal resp. PTFE/EPDM with a ventilated clearance from Medium. The valve is used for shut-off, dosing, filling, ventilating and distributing Medium with low pressures; also with technical Vacuum for DN 10mm.

Circuit function C

3/2-way valve, direct-acting,
in de-energized position,
port A exhausted

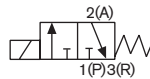

Circuit function D

3/2-way valve, direct acting,
in de-energized position,
port B pressurized

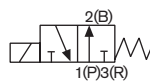

Circuit function E

mixer valve, direct-acting,
in de-energized position,
P2→A open, P1 closed

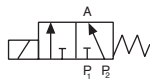

Circuit function F

distribution valve, direct-acting,
in de-energized passage,
P→B open

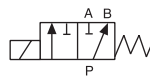

Technical data

Body material	Brass
Seal material	NBR (EPDM or FKM on request)
Medium	Neutral fluids such as z.B compressed air, water, hydraulic oil, oils and fats without additives, technical vacuum
Medium temperature	-10 to +80 °C
Ambient temperature	Max +50 °C
Viscosity	100 to 15 mm ² /s
Operating voltage	230 V 50 Hz 24/230 V UC other voltages on request
Voltage tolerance	±10 %
Cycling rate	Max. 100-150/min with AC Max. 6/min with UC
Duty cycle	100%
Electrical connection	Cable Plug (supplied as standard)
Protection class	IP65 with Cable Plug
Installation	As required, preferably with actuator upright
Response times [ms]	Measured at valve outlet with air at 6 bar and +20 °C Opening Closing

Flow rate: Kv value water [m³/h]

¹⁾Measured at +20 °C, 1 bar pressure at valve inlet and free outlet.

Pressure values [bar]

Measured as overpressure to the atmospheric pressure

Technical data (cont.)

Orifice [mm]	Kv value water [m ³ /h]	Port connection	Pressure range [bar]	Electr. power consumption			Response times		Weight [kg]
				Inrush	[VA]	Opening	closed		
10	2.0	G 3/8	0-1	AC UC	100 VA 100 W	48 VA (16W) 9 W	10 to 20	40 to 60	1.5
15	4.0	G 1/2	0-0.5						1.5
20	5.0	G 3/4	0-0.25						1.5

Materials

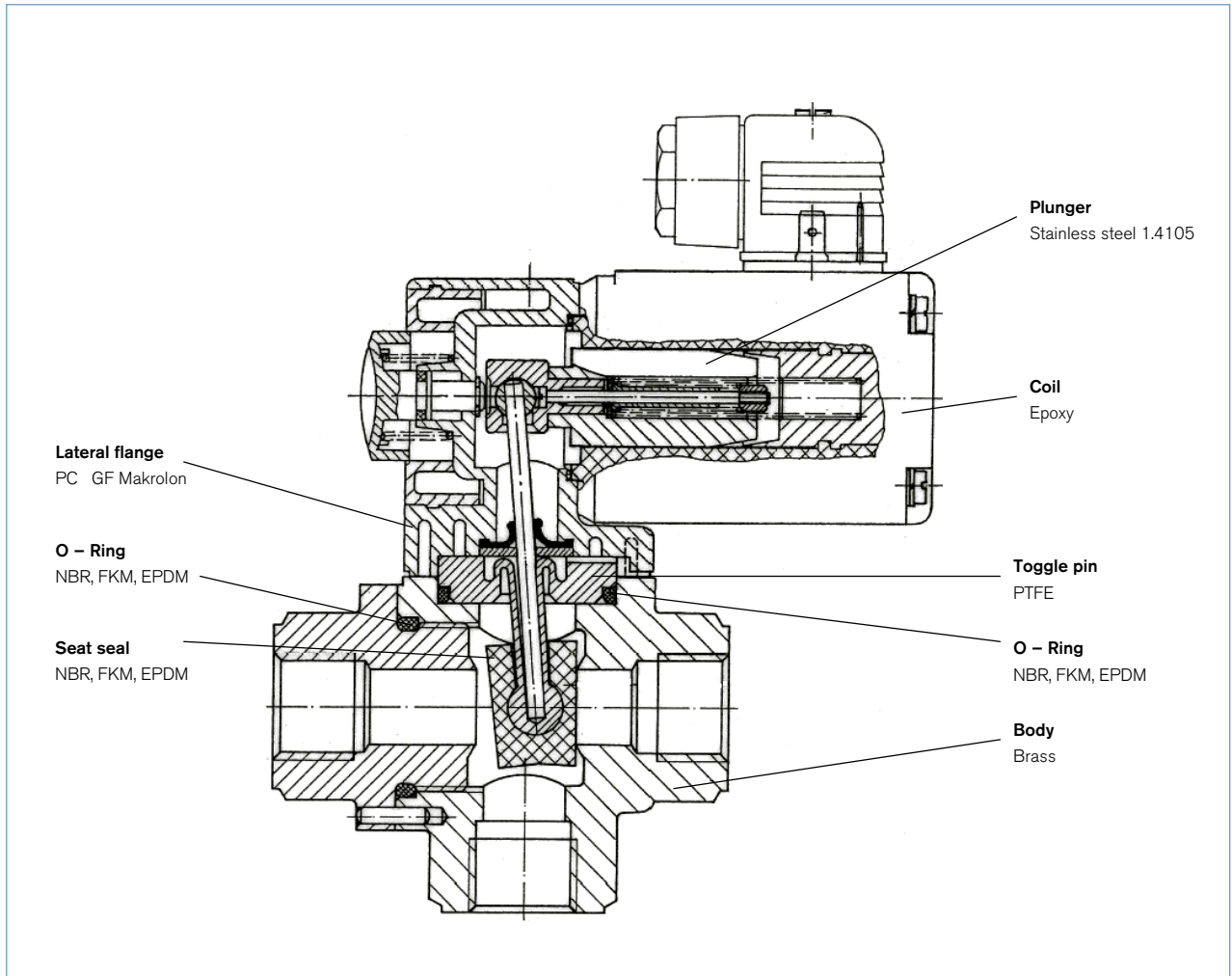

Ordering chart for valves (other versions on request)

All valves with manual override, brass body, NBR seal and cable plug

Circuit function	Orifice [mm]	Port connection	Kv value water [m ³ /h]	Pressure range [bar]	Voltage/ Frequency [V/Hz]	Item no.
C	10.0	G 3/8	2.0	0-1	24/UC	048 997
					230/UC	059 302
	15.0	G 1/2	4.0	0-0.5	24/UC	062 737
					230/UC	062 481
	20.0	G 3/4	5.0	0-0.25	230/UC	049 470
	D	10.0	G 3/8	2.0	0.1	24/UC
230/UC						063 147
15.0		G 1/2	4.0	0-0.5	24/UC	021 964
F	10.0	G 3/8	2.0	0-1	24/UC	064 025
					230/UC	062 960
	15.0	G 1/2	4.0	0-0.5	24/UC	058 843
					230/UC	062 124
	20.0	G 3/4	5.0	0-0.25	230/UC	079 567

- Valves in circuit function E on request
- Valves with orifice 15 and 20 mm are not suitable for vacuum

Further versions on request



Electrical connection
with electrical position feedback



Materials
Other seal materials (EPDM or FKM)

Dimensions [mm]

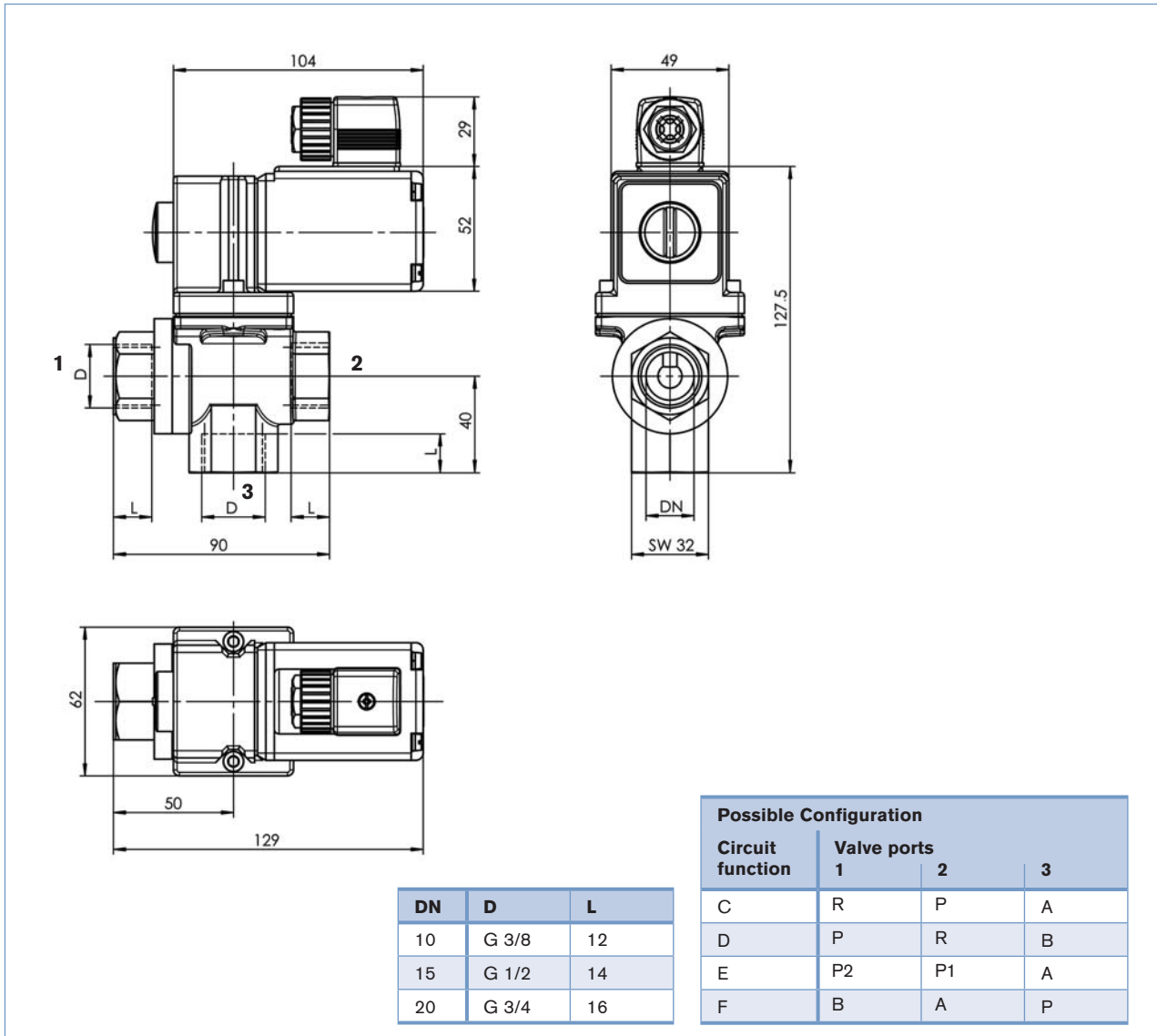

DTS 1000119516 EN Version: B Status: RL (released | freigegeben | valide) printed: 10.01.2018

To find your nearest Bürkert facility, click on the orange box →

www.burkert.com

In case of special application conditions, please consult for advice.

Subject to alterations
© Christian Bürkert GmbH & Co. KG

1007/3_EU-en_00895105