

2/2-way Solenoid Valve

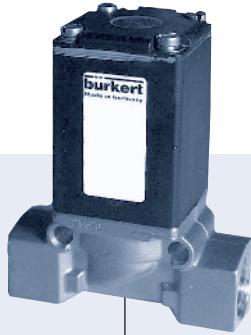

Type 0256 can be combined with...

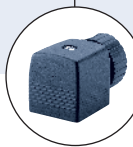

Type 2508
Cable plug





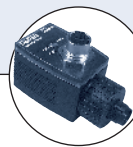

Type 1078
Timer unit



Type 2511
ASI cable plug



Type 8600
Dosing control

- Seat valve, direct-acting
- Wide range of applications
- Port connection size up to NPT 1/2
- Brass or stainless steel valve body
- Approvals:     

This direct-acting plunger solenoid valve Type 0256 can be used in many ways. It is delivered with brass or stainless steel bodies for a wide range of orifices and connections.

Power consumption			
Orifice	Inrush	Hold	
[mm]	AC [VA]	AC [VA/W]	DC [W]
3.0-12.0	35-40	16/10	approx. 12

Circuit function A

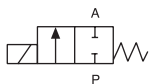

2/2-way valve, normally closed by spring force

Technical data	
Orifice	5/64" – 7/16" (DN 2.0 – 12.0 mm)
Body materials	Brass (Body C with stainless steel seat 1.4112) Or stainless steel 1.4581
Seal material	FKM, EPDM, (steel on request)
Media	FKM EPDM All materials
	Neutral media, compressed lubricated air, water, oil, oils with additives, oxygen Oil, fat-free fluids e.g., hot water, alkaline washing, bleaching lyles Technical vacuum
Media temperature	FKM EDPM
	14°F to 266°F (-10°C to +130°C) -40°F to 266°F (-40°C to +130°C)
Ambient temperature	Max. 131°F (+55°C)
Viscosity	Max. 21 cst
Voltage tolerance	±10%
Duty cycle	100% continuous rating
Electrical connection	Cable plug for Ø 7 mm cable (sold separately)
Protection class	IP 65 with cable plug
Installation	As required, preferably with actuator upright
Flow rate	measured at 68°F (+20°C), 1 PSI pressure at valve inlet and free outlet
Pressure valves [PSI]	gauge pressures with respect to the prevailing atmosphere pressure
Response times [ms]	measured with water at valve outlet at 87 PSI and 68°F (+20°C)
	Opening Closing
	pressure build-up 0 to 90% pressure decay 100 to 10%

Solenoid valve specifications

Orifice DN [mm]	C _v Value Water [gpm]	QNn Value Air [SCPM]	Pressure Range AC		DC Liquids and Gases [PSI]	Weight [kg]
			Liquids [PSI]	Gases [PSI]		
2	0.14	4.6	0 - 580.0	0 - 580.0	0 - 435.0	0.60
3	0.29	9.5	0 - 319.0	0 - 319.0	0 - 145.0	0.60
4	0.58	19.0	0 - 174.0	0 - 232.0	0 - 87.0	0.60
5	0.76	25.0	0 - 87.0	0 - 174.0	0 - 36.0	0.60
6	0.93	30.0	0 - 56.0	0 - 116.0	0 - 14.5	0.60
8	1.05	34.0	0 - 22.0	0 - 36.0	0 - 7.2	0.60
10	1.75	56.0	0 - 14.5	0 - 22.0	0 - 5.8	0.60
12	2.10	68.0	0 - 7.2	0 - 14.5	0 - 1.5	0.60

NOTE: Valves labeled with pressure range for liquids

Dimensions [mm]

Body	Body material	Connection D	H	SW
A	Brass, stainless steel body without bore hole mounting	NPT 1/2	95.5	27
B	Brass body with bore hole mounting	NPT 1/4, NPT 3/8	93.0	22
B	Stainless steel body without bore hole mounting	NPT 1/4	93.0	22
C	Brass body with bore hole mounting	NPT 1/4, NPT 3/8	92.0	22

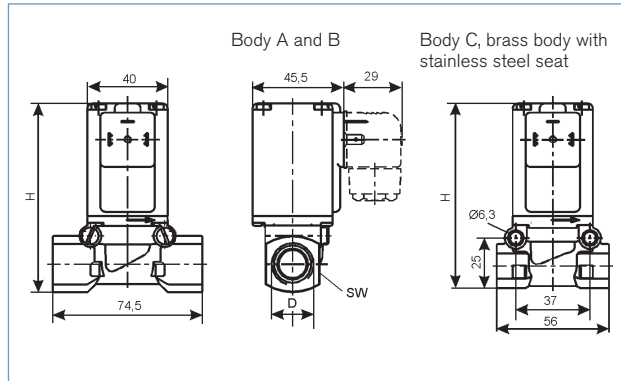

Mounting set

Mounting set

- 2 M6 x 35 cheesehead screws
 - 1 mounting bracket
- Valve mounted using mounting kit
Refer to the dimensional drawings for the valve
37 mm separation between the M6 threaded holes 48 mm separation between the Ø7 bores

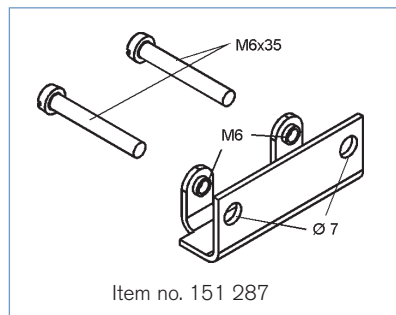

2509 Dimensions

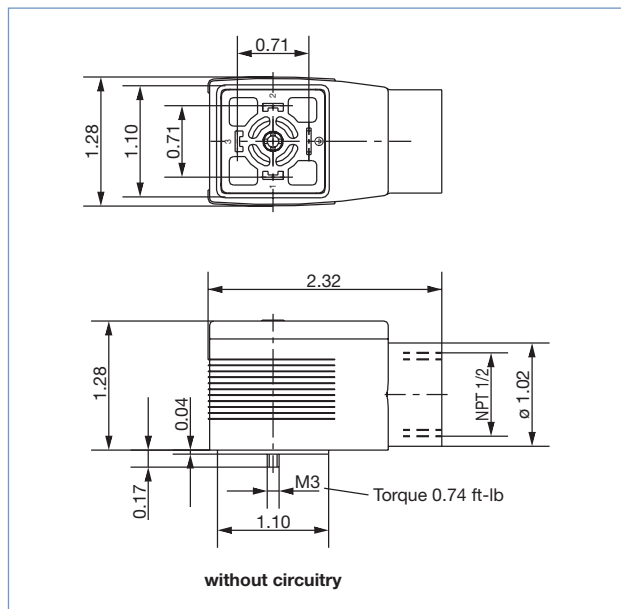

* Included on all UL listed valves

Ordering chart for valves (other versions on request)

Valves A, B, C with brass body, DN 2.0 to 12.0 mm, with cable plug, without mounting bracket (see Accessories)

Body C with stainless steel seat 1.4112

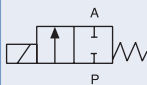
Circuit function	Orifice DN [mm]	Flow Rate		Port connection [NPT]	Pressure range ²⁾ [PSI] 	Body material/style	Seal material	Approval ³⁾	Voltage/frequency [V/Hz]	Mounting bracket	Item no.
		Water C _v valve [gpm]	Air ¹⁾ Q _{Nn} [SCFM]								
A 2/2-way valve NC 	2.0	.14	4.6	1/4	0 - 435	Brass/B	FKM	-	12/DC	N	453 471 Y
					0 - 580	Stainless/B	FKM	UR/CSA	120/60	N	450 047 B
					0 - 580	Stainless/B	FKM	FM/UL/CSA	120/60	N	US00735
	3.0	.29	9.5	1/4	0 - 319	Brass/C	FKM	UR/CSA	120/60	N	450 048 L
					0 - 319	Brass/C	FKM	FM/UL/CSA	120/60	N	452 814 P
					0 - 87	Brass/C	FKM	-	24/DC	N	450 588 F
					0 - 87	Brass/C	FKM	UR/CSA	24/DC	N	454 519 Z
					0 - 87	Brass/C	FKM	FM/UL/CSA	24/DC	N	US03974
					0 - 232	Brass/C	FKM	UR/CSA	120/60	N	450 050 J
					0 - 232	Brass/C	FKM	FM/UL/CSA	120/60	Y	452 820 Z
					0 - 87	Stainless/B	FKM	UR/CSA	24/DC	N	452 466 S
					0 - 87	Stainless/B	FKM	FM/UL/CSA	24/DC	N	452 915 L
					0 - 232	Stainless/B	FKM	UR/CSA	120/60	N	450 052 G
					0 - 232	Stainless/B	FKM	FM/UL/CSA	120/60	N	452 918 X
					3/8				0 - 87	Brass/C	FKM
	0 - 232	Brass/C	FKM	UR/CSA					120/60	N	450 051 F
	0 - 232	Brass/C	FKM	FM/UL/CSA					120/60	Y	451 923 K
	0 - 174	Brass/C	FKM	-					24/60	N	450 883 X
	0 - 174	Brass/C	FKM	UR/CSA					120/60	N	450 054 A
	0 - 116	Stainless/B	EPDM	UR/CSA					120/60	N	455 295 S
	5.0	.76	25.0	1/4	0 - 116	Stainless/B	EPDM	UR/CSA	240/60	N	455 294 Z
					0 - 29	Brass/B	FKM	-	12/DC	N	450 618 L
					0 - 116	Brass/C	FKM	UR/CSA	24/60	N	450 057 D
					0 - 29	Brass/C	FKM	UR/CSA	24/DC	N	454 522 L
					0 - 116	Brass/C	FKM	UR/CSA	120/60	N	450 058 N
					0 - 116	Brass/C	FKM	FM/UL/CSA	120/60	N	454 407 S
					0 - 116	Brass/B	FKM	UR/CSA	120/60	N	452 471 X
					0 - 116	Brass/B	FKM	FM/UL/CSA	120/60	N	453 010 Z
					0 - 116	Brass/B	FKM	UR/CSA	120/60	Y	US06479
					0 - 116	Stainless/B	FKM	UR/CSA	24/60	N	458 125 S
0 - 29					Stainless/B	FKM	UR/CSA	24/DC	N	452 481 J	
0 - 29					Stainless/B	FKM	FM/UL/CSA	24/DC	N	US02633	
6.0	.93	30.0	1/4	0 - 116	Stainless/B	FKM	UR/CSA	120/60	N	450 061 H	
				0 - 116	Stainless/B	FKM	FM/UL/CSA	120/60	N	452 933 N	
				0 - 29	Brass/B	FKM	UR/CSA	24/DC	N	452 473 Z	
				0 - 116	Brass/C	FKM	UR/CSA	120/60	N	450 059 P	
				0 - 116	Brass/B	FKM	UR/CSA	120/60	N	450 766 Q	

1) Measured with 85 upstream pressure and 14.5 PSI pressure drop across the valve at 68°F.

2) Also applies for technical vacuum.

3) UL listed for safety shutoff.

FM approved Class I, II, III Division 2 Groups A, B, C, D, F, G.

CSA approved for safety shutoff.



All valves carry CE approval.

 Limited pressure range for liquids (see chart on page 2)

Ordering chart for valves (other versions on request)

Valves A, B, C with brass body, DN 2.0 to 12.0 mm, with cable plug, without mounting bracket (see Accessories)

Body C with stainless steel seat 1.4112

Circuit function	Orifice DN [mm]	Flow Rate		Port connection [NPT]	Pressure range ²⁾ [PSI] 	Body material/style	Seal material	Approval ³⁾	Voltage/frequency [V/Hz]	Mounting bracket	Item no.						
		Water C _v valve [gpm]	Air ¹⁾ Q _N [SCFM]														
A 2/2-way valve NC 	6.0	.93	30.0	3/8	0 - 116	Brass/B	FKM	FM/UL/CSA	120/60	Y	453 012 P						
					1/2	0 - 29	Stainless/A	EPDM	-	24/DC	N	453 327 X					
						0 - 116	Stainless/A	EPDM	UR/CSA	120/60	N	455 296 T					
						0 - 116	Stainless/A	EPDM	UR/CSA	240/60	N	455 018 X					
						0 - 116	Brass/A	FKM	UR/CSA	24/60	N	452 476 U					
						0 - 116	Brass/A	FKM	FM/UL/CSA	24/60	N	452 927 Q					
				0 - 29		Brass/A	FKM	UR/CSA	24/DC	N	450 055 B						
				8.0	1.05	34.0	1/2	0 - 36	Brass/A	FKM	FM/UL/CSA	120/60	N	452 937 J			
								0 - 7.2	Stainless/A	FKM	FM/UL/CSA	24/DC	N	456 477 Z			
								0 - 36	Stainless/A	FKM	UR/CSA	120/60	N	450 064 C			
								0 - 36	Stainless/A	FKM	FM/UL/CSA	120/60	N	452 941 W			
								0 - 36	Stainless/A	FKM	FM/UL/CSA	240/60	N	452 942 X			
								0 - 116	Stainless/A	FKM	UR/CSA	120/60	N	450 060 L			
							10	1.75	56.0	3/8	0 - 5.8	Brass/B	FKM	UR/CSA	24/DC	N	452 490 X
											0 - 22	Brass/B	FKM	UR/CSA	120/60	N	450 066 E
											0 - 22	Brass/B	FKM	FM/UL/CSA	120/60	N	452 945 S
										1/2	0 - 22	Brass/B	FKM	UR/CSA	240/60	N	452 492 M
											0 - 22	Brass/B	FKM	FM/UL/CSA	240/60	N	US01308
	0 - 22	Brass/A	FKM								UR/CSA	120/60	N	450 065 D			
	12	2.10	68.0	1/2	0 - 22	Brass/A	FKM	FM/UL/CSA	120/60	Y	452 949 E						
					0 - 5.8	Stainless/A	FKM	UR/CSA	24/DC	N	452 496 R						
					0 - 5.8	Stainless/A	FKM	FM/UL/CSA	24/DC	N	455 102 Z						
					0 - 22	Stainless/A	FKM	UR/CSA	120/60	N	450 067 F						
					0 - 22	Stainless/A	FKM	FM/UL/CSA	120/60	N	455 054 T						
					0 - 1.4	Brass/A	FKM	-	12/DC	N	454 525 P						
	12	2.10	68.0	1/2	0 - 14.5	Brass/A	FKM	UR/CSA	120/60	N	452 499 U						
					0 - 14.5	Brass/A	FKM	FM/UL/CSA	120/60	N	452 957 W						
					0 - 1.4	Stainless/A	FKM	-	24/DC	N	451 974 W						
					0 - 14.5	Stainless/A	FKM	-	120/60	N	454 770 Q						
					0 - 14.5	Stainless/A	FKM	FM/UL/CSA	120/60	N	US01049						
					0 - 14.5	Stainless/A	FKM	FM/UL/CSA	120/60	N	US01049						

1) Measured with 85 upstream pressure and 14.5 PSI pressure drop across the valve at 68°F.

2) Also applies for technical vacuum.

3) UL listed for safety shutoff. FM approved Class I, II, III Division 2 Groups A, B, C, D, F, G. CSA approved for safety shutoff. All valves carry CE approval.

 Limited pressure range for liquids (see chart on page 2)