

2/2 or 3/2-way Solenoid Valve for aggressive media

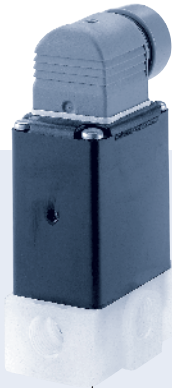

- 1/4" NPT ports
- Pivoted armature "flipper" valve with lockable manual override
- Direct-acting with separating diaphragm
- Suitable for aggressive media
- Body materials: polypropylene and PVDF
- Ideal for medical waste lines and dialysis equipment

Type 0124 can be combined with...

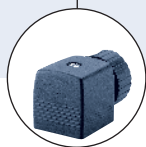

Type 2508
Cable plug



Type 1078
Timer unit

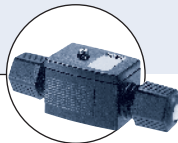

Type 2511
ASI cable plug

The Type 0124 is a direct-acting 2/2 or 3/2-way pivoted armature solenoid valve. Available in many circuit functions for opening, closing, dosing, mixing and distribution. The magnetic system and the media chamber are separated by a diaphragm system.

Circuit function A

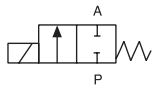

2/2-way valve NC

Circuit function C

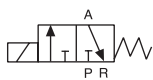

3/2-way valve NC

Circuit function E

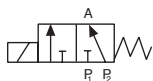

3/2-way mixer valve

Circuit function F

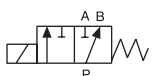

3/2-way distribution valve

Normally open 2/2-way and 3/2-way also available

Technical data

Orifice [inch]	5/64 to 3/16 (2mm to 5mm)
Body and seat material	PP, PVDF
Seal material	EPDM, FKM, FFKM
Media	
EPDM	Alkalis, acids up to medium concentrations, alkaline washing and bleaching lyes
FKM	Oxidising acids and substances, oils, salt solutions, waste gases
Media temperatur	
EPDM	-22°F to 176°F (-30°C to +80°C)
FKM	32°F to 176°F (0°C to +80°C)
Ambient temperature	max. 131°F (+55°C)
Standard voltages	12, 24 VDC, 24, 120, 240 VAC
Voltage tolerance	± 10%
Duty cycle	Intermittent operation 40% (30 min) with 8 W version or 100% continuous rating with 5 W version (on request)
Electrical connection	Cable plug for Ø 7 mm (supplied as standard)
Protection class	IP 65 with cable plug
Installation	As required, preferably with actuator upright

Materials

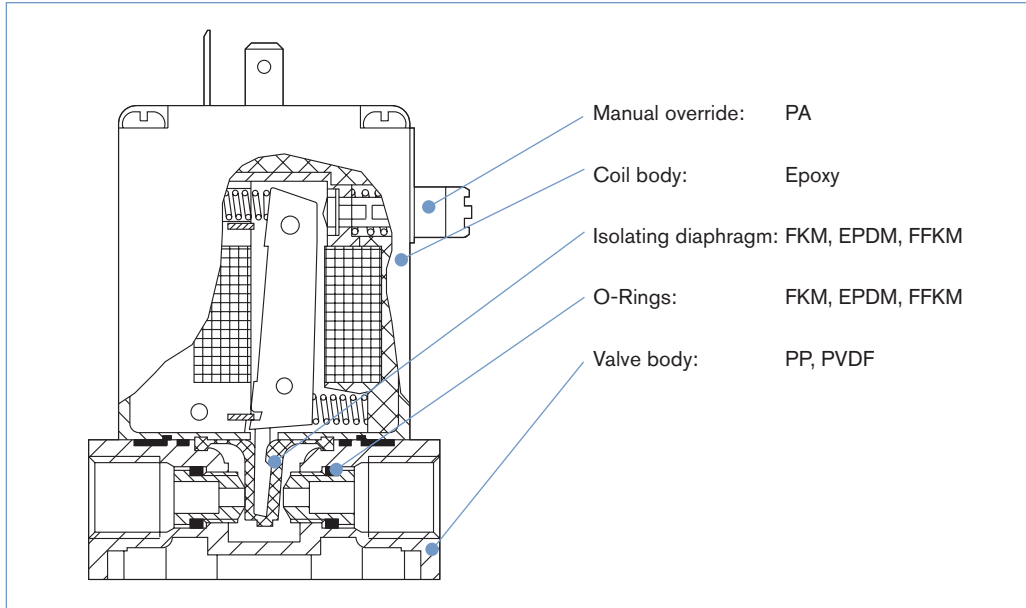

Technical data

Inrush		Hold		Weight kg
AC [VA]	DC [W]	AC [VA/W]	DC [W]	
30	8	15/8	8	0.4

Specifications – ordering chart (other versions on request)

0124 ported PP valve body

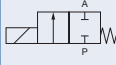
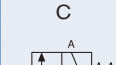
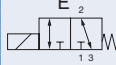
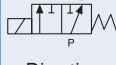
Circuit function	Port connection	Orifice [inch]	C _v	Q _{Nn} Value (air) [l/min]	Pressure range [PSI]	Seal material	Item No. Voltage / Frequency [V/Hz]		
							24/DC ¹⁾	120/60	240/60
 Normally closed	NPT 1/4	5/64	0.15	120	0 – 174	EPDM	457 472	457 473	457 474
		1/8	0.29	250	0 – 115	FKM	457 469	457 470	457 471
						EPDM	454 952	453 648	457 476
		5/32	0.33	325	0 – 58	FKM	451 963	454 841	457 475
						EPDM	452 810	452 799	454 089
		3/16	0.47	440	0 – 43	FKM	455 220	453 577	454 726
EPDM	454 376					450826	–		
 C	NPT 1/4	5/64	0.15	120	0 – 174	EPDM	–	453 972	–
		1/8	0.29	250	0 – 115	FKM	–	454 041	–
						EPDM	066 239	454 197	454 694
		5/32	0.33	325	0 – 58	FKM	453 518	453 578	–
						EPDM	454 202	454 792	454 500
		3/16	0.47	440	0 – 43	FKM	455 554	453 650	–
EPDM	457 480					457 481	457 482		
 E ₂ Universal function, any flow direction	NPT 1/4	5/64	0.15	120	0 – 100	EPDM	–	–	457 482
		1/8	0.29	250	0 – 58	FKM	–	–	457 479
						EPDM	457 486	457 487	457 488
		5/32	0.33	325	0 – 29	EPDM	–	–	–
						FKM	–	–	457 485
		3/16	0.47	440	0 – 29	EPDM	–	–	–
FKM	–					459 365	459 364		
 F	NPT 1/4	5/64	0.11	120	0 – 174	EPDM	–	–	–
		1/8	0.29	250	0 – 115	FKM	–	–	–
						EPDM	–	–	–
		5/32	0.33	325	0 – 58	FKM	455 594	454 300	–
						EPDM	453 581	452 714	454 721
		3/16	0.47	440	0 – 43	FKM	456 174	454 192	454 248
EPDM	461 261					–	450 531		
					FKM	–	–	–	

¹⁾ C_v reduced by 20% for DC voltages

Specifications – ordering chart ...continued (other versions on request)

0124 ported PVDF valve body

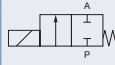
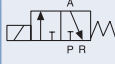
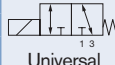
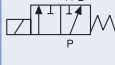
Circuit function	Port connection	Orifice [inch]	C _v	Q _{Nn} Value (air) [l/min]	Pressure range [PSI]	Seal material	Item No. Voltage / Frequency [V/Hz]			
							24/DC ¹⁾	120/60	240/60	
 Normally closed	NPT 1/4	5/64	0.15	120	0 – 174	EPDM	457 492	457 493	457 494	
		1/8	0.29	250	0 – 115	FKM	457 489	457 490	457 491	
							EPDM	450 922	450 924	457 497
							FKM	454 200	457 495	457 496
		5/32	0.33	325	0 – 58	EPDM	–	–	–	
		3/16	0.47	440	0 – 43	FKM	089 611	454 285	–	
 C	NPT 1/4	5/64	0.15	120	0 – 174	EPDM	–	–	–	
		1/8	0.29	250	0 – 115	FKM	–	–	–	
							EPDM	457 964	–	455 548
							FKM	454 480	453 579	–
		5/32	0.33	325	0 – 58	EPDM	–	–	–	
		3/16	0.47	440	0 – 43	FKM	–	454 149	–	
 E Universal function, any flow direction	NPT 1/4	5/64	0.15	120	0 – 100	EPDM	457 501	457 502	457 503	
		1/8	0.29	250	0 – 58	FKM	457 498	457 499	457 500	
							EPDM	457 507	457 508	457 509
							FKM	457 504	457 505	457 506
 F Diverting	NPT 1/4	5/64	0.11	120	0 – 174	EPDM	–	–	–	
		1/8	0.29	250	0 – 115	FKM	–	–	–	
							EPDM	452 704	472 706	–
							FKM	139 225	–	–
		5/32	0.33	325	0 – 58	EPDM	452 712	–	–	
		3/16	0.47	440	0 – 43	FKM	–	–	–	
					EPDM	462 471	–	–		
					FKM	–	–	–		

¹⁾ C_v reduced by 20% for DC voltages

Options

- Diagnosis: Electrical feedback signaller
- Specific clean and testing
- Vacuum version
- Impulse coil
- Manifold version, Type 0125

Dimensions

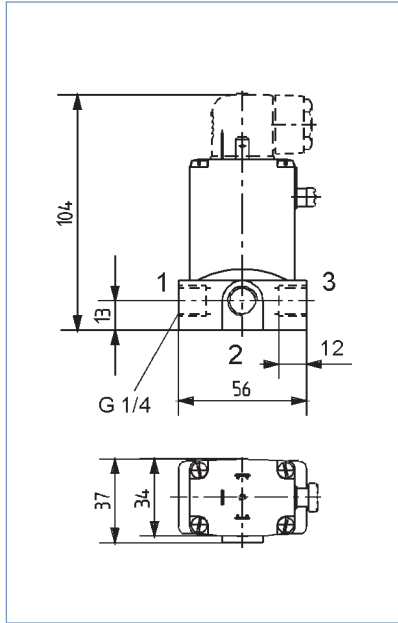

The ports are marked with 1, 2 and 3 as indicated in the configuration table, depending on the circuit function.

Possible port configurations

Circuit function	1	2	3
A ¹⁾	A	-	P
C	P	A	R
E	P1	A	P2
F	A	P	B

¹⁾ Type 0124 has no middle connection in circuit function A.

The springs of each valve are set up for a specific circuit function. When using them in other circuit functions, the permissible operating pressure changes according to the following table.

Circuit function	Max. operating pressure [PSI] when using the valve in a new circuit function											
	Orifice 3.0						Orifice 4.0					
	A	B	C	D	E	F	A	B	C	D	E	F
C	145	14.5	145	14.5	14.5	145	72.5	11.6	72.5	11.6	11.6	72.5
D	87	87	87	87	87	43.5	43.5	43.5	43.5	43.5	43.5	43.5
F	72.5	14.5	87	14.5	14.5	145	58	14.5	58	14.5	14.5	58



Engineering Design and Contract Manufacturing services available for your micro-fluidic system needs. Specializing in Value added Design and Fabrication of manifolds, brackets, cable harnesses and more. Manufacturing services include complete documentation, CAD, assembly and testing of complete systems and sub-assemblies including: valve mounting, fitting and tubing installation, cable harnesses, power boards, sheet metal and more.