



Type 0121 can be combined with...



Type 2508

Cable plug



Type 1078

Timer control

The 0121 valve is a direct-acting, media-separated pivoted armature valve. It is available in 3/2- and 2/2-way versions. As a 3/2-way version, it can be used as a distributor or mixing valve. Various diaphragm material combinations and methods of operation are available depending on the application. The housing offering includes stainless steel (316L), PTFE, and PVC versions. The solenoid coils are moulded with a chemically resistant epoxy. The 0121 is equipped with manual override for commissioning and testing. For reduced energy requirements, all coils can be delivered with electronic power reduction or as an impulse version. The switching status can be indicated with position feedback as a binary or NAMUR signal. In combination with a plug in accordance with DIN EN 17301-803 Form A, the valves satisfy protection class IP65/67 – in combination with a stainless steel or plastic housing NEMA 4X.

Content:

Standard version

Technical data	p. 1
Additional options	p. 3
Dimensions & Pin Assignment	p. 4
Ordering chart	p. 5

Explosion proof version

Technical data	p. 6
Additional options	p. 7
Dimensions & Pin Assignment	p. 8

2/2- and 3/2-way solenoid valve for aggressive fluids

- Direct-acting, media-separated valve with diameter of up to DN 8
- Maintenance-free pivoted armature technology
- Vibration-proof, block screwed coil system
- Service-friendly, durable manual override
- Explosion proof version

Technical data	
Orifice	DN2.0 to 8.0
Available housing materials	PTFE PVC (resistant acc. to DIN 8062, 8061) PP (Polypropylen) PVDF Stainless steel 1.4401
Seal materials	FKM / FFKM / EPDM
Medium	
for FKM	Oxydizing acids and substances, hot oils with additives, salt solutions, waste gases
for FFKM	Aggressive fluids, hot air, hot oils, Aromate, ether, Esther, ketones (please note Bürkert chemical resistance chart). Alkalis, acids up to medium concentration, alkaline washing- and bleaching lyes
for EPDM	
All Materials	For more detailed information please consult the resistance chart
Medium temperature for body material PVDF oder PP	EPDM: -30 to +70 °C FKM: -10 to +70 °C FFKM: -10 to +70 °C
Medium temperature for body material PTFE or VA	EPDM: -30 to +90 °C FKM: -10 to +90 °C FFKM: -10 to +90 °C
Medium temperature for body material PVC	EPDM: -30 to +50 °C FKM: -10 to +50 °C FFKM: -10 to +50 °C
Ambient temperature	Max. +50 °C
Viscosity	Max. 37 mm ² /s
Voltages	24 V 50 Hz; 110 V 50 Hz; 230 V 50 Hz; 120 V 60 Hz; 240 V 60 Hz; 12 V DC; 24 V DC; (Further voltages on request)
Voltage tolerance	+/- 10%
Cycling rate	max. 100/min with AC max. 10/min for UC (high-capacity electronic)
Duty cycle for VA	100%
Duty cycle bei PVDF, PP and PTFE	40% ED (60% intermittent operation) in 10 min bei 8 W-version 100% ED for 5 W-version or high-capacity electronic
Duty cycle for PVC	with PVC 10% ED (10 min) 100% ED for version with high-capacity electronic

Circuit functions

A 2/2 way direct-acting solenoid valve, normally closed

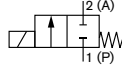

B 2/2 way direct-acting solenoid valve, normally open

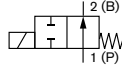

C 3/2 way direct-acting solenoid valve, normally closed

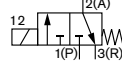

D 3/2 way direct-acting solenoid valve, normally open

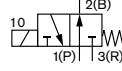

E 3/2 way mixing solenoid valve

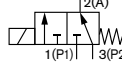

F 3/2 way direct-acting, distribution solenoid valve

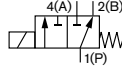

T 3/2 way direct-acting solenoid valve, flow direction optional

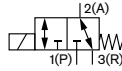

Technical data (continued)

Electrical connection	Tag connector acc. to DIN EN 175301-803 Form A for Cable plug type 2508/2509 (on request also with injected cable or terminal box)
Protection class	IP65 with cable plug
Thermal insulation class of the coil	H
Installation	As required, preferably with actuator upright
Weight [kg]	
Material VA	0,9
Material PVDF, PP und PVC	0,38
Material PTFE	0,5

Power consumption standard

Frequency: AC Inrush [VA]	Operation [VA]	Operation [W]	Frequency: DC	
			Cold [W]	Warm [W]
30	15	8	11	8

Response times

Frequency: AC Opening [ms]	Closing [ms]	Frequency: DC	
		Opening [ms]	Closing [ms]
20	11	11	8

Response times [ms]:

Measurement at the valve output 6 bar and +20 °C

Opening: Pressure rise 0 to 90%,

Closing: Pressure drops 100 to 10%

Pressure range and flow rate

Circuit function	DN	KV-value water [m³/h]	Pressure range [bar]	
			Frequency AC [50 o. 60 Hz] ¹⁾	Frequency DC ¹⁾
A / F	2	0,1	0 – 6	0 – 3
	4	0,3 ²⁾	0 – 4	0 – 2
	6	0,6 ³⁾	0 – 2	0 – 1
	8	1,0	0 – 1	0 – 0,8
C / D	2	0,1	0 – 3	0 – 1,5
	4	0,3 ²⁾	0 – 2	0 – 1
	6	0,6 ³⁾	0 – 1	0 – 0,5
	8	1,0	0 – 0,3	0 – 0,3
B	2	0,1	0 – 6	0 – 3
	4	0,3 ²⁾	0 – 4	0 – 2
	6	0,6 ³⁾	0 – 2	0 – 1
	8	1,0	0 – 1	0 – 0,5
E	2	0,1	0 – 3	0 – 1,5
	4	0,3 ²⁾	0 – 2	0 – 1
	6	0,6 ³⁾	0 – 1	0 – 0,5
	8	1,0	0 – 0,2	0 – 0,2

¹⁾ Heat output 8 W

²⁾ Nominal size 4 mm and seal material FKM or FFKM KV-value reduces to 0,24 m³/h

³⁾ Nominal size 6 mm and seal material FKM bzw. FFKM KV-value reduces to 0,48 m³/h

Materials

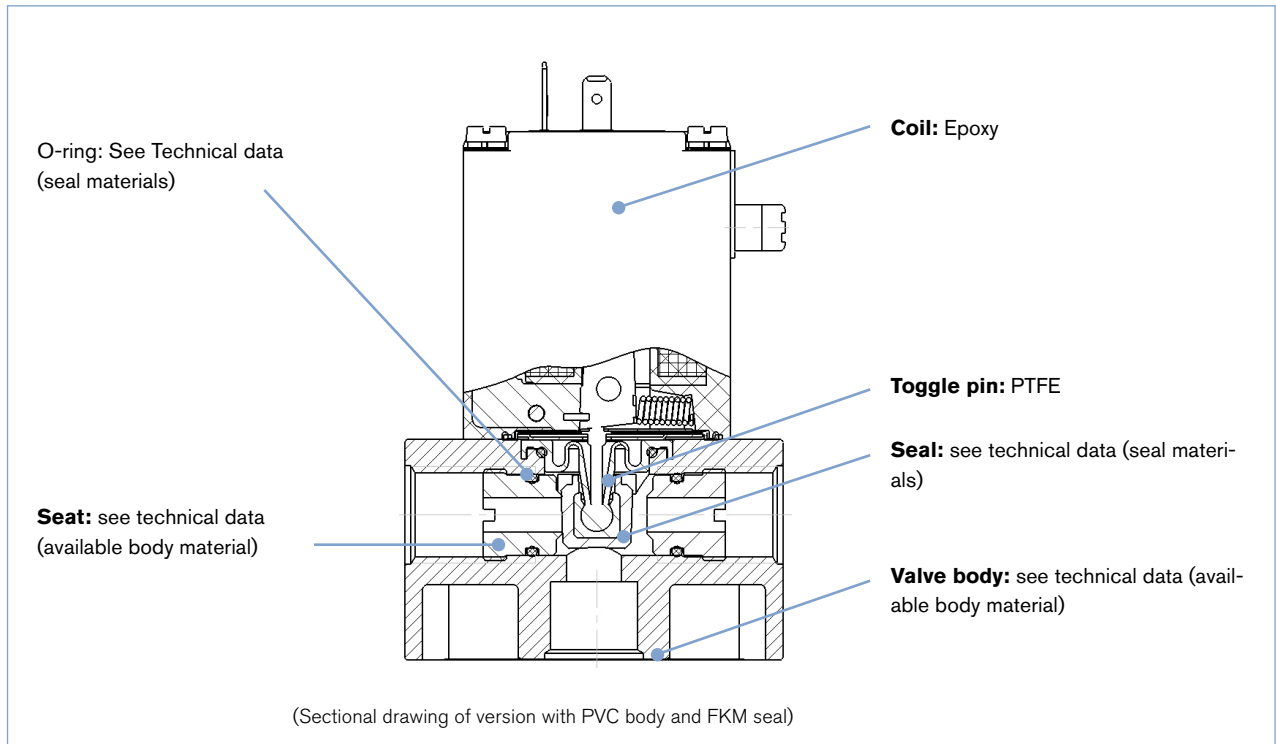

Additional options

Option	Variable code	Specifications
Oxygen versions	NL02	Suitable for application with oxygen (non-metallic materials in contact with medium are BAM-proofed)
Higher purity requirements e.g. oil-, grease- and silicon free	NL05	Parts in contact with the medium are specially cleaned and the valves appropriate packed
Electrical feedback	LF03	See type 1060
high-capacity electronic	CZ05	Inrush power 60 W, holding current 3 W; With plastic type 100% ED feasible
Vacuum version	NA02	Suitable for vacuum up to -0,98 bar
Improved purity and tightness requirements	NA03	Parts in contact with the medium are specially cleaned and the leak test to 10 ⁻⁴ mbar x l / sek
Coil with reduced performance (5 W)		Devised have smaller pressure rangen; for plastic version 100% ED is achievable
Cable plug	JFxx/JGxx	Cable plug is part of the delivery. Cable plug versions (acc. to DIN EN 175301-803 Form A), see separate datasheet type 2508 and 2509
Approvals	PD02	UL recognized General Purpose valve CSA General Purpose valve
Possible conformity (depending on construction)		EAC; Drinking water; FDA

Dimensions [mm]

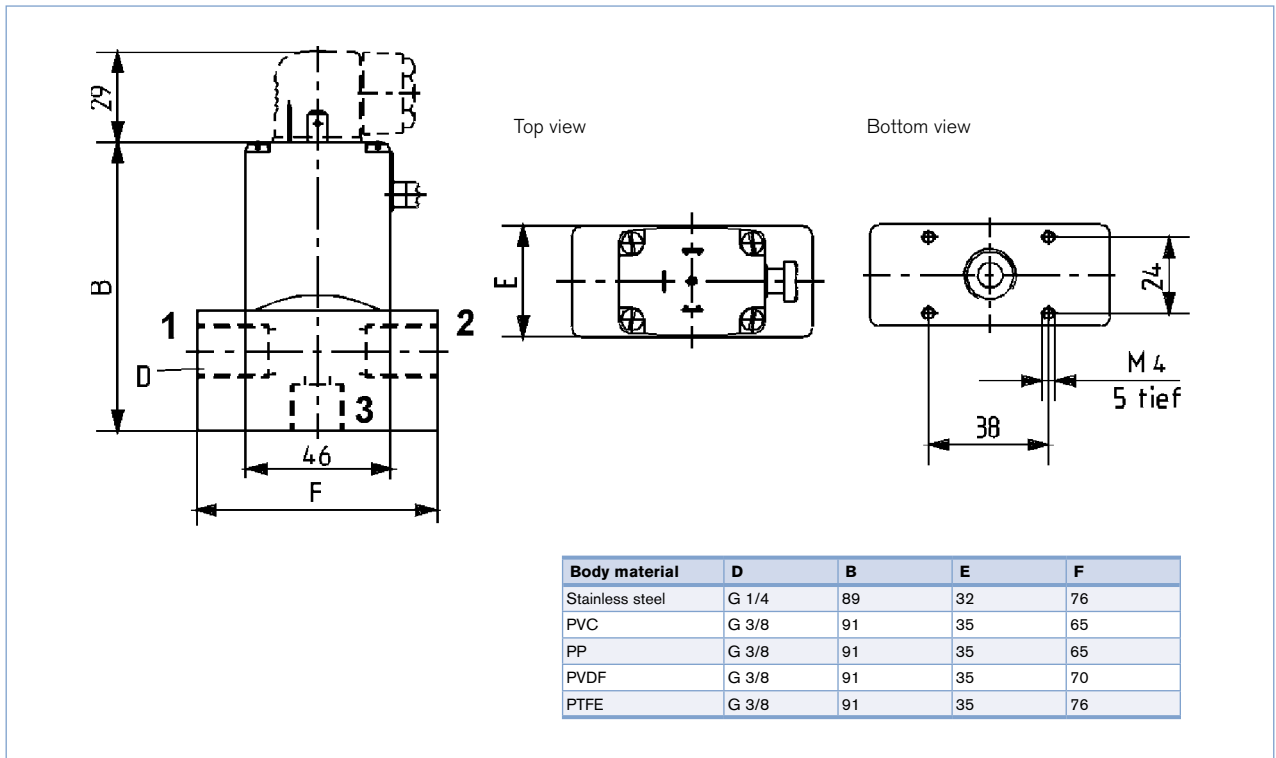

PIN Assignments

The connections marked with 1, 2 and 3 are labelled in the drawing according to the circuit function table on the left.

Circuit function	Connection 1	Connection 2	Connection 3
A	A	P	
B	P	B	
C	P	R	A
D	R	P	B
E	P1	P2	A
F	A	B	P

Ordering chart (Articles with reduced delivery time)

Valves with plastic or stainless steel body, manual override and cable plug (UC with silicon cable, see footnote)

Circuit function	Orifice [mm]	Power connection	Seal material	Body or seat material	Item no. per voltage/frequency [V/Hz]			
					024/DC	024/50	230/50	120/60
A ¹⁾	4,0	G 3/8	FKM	PVC	049654 ²⁾	048940 ²⁾	047859 ²⁾	-
	4,0	G 3/8	EPDM	PVC	050795 ²⁾	050085 ²⁾	049267 ²⁾	-
	6,0	G 3/8	FKM	PVC	048749 ²⁾	049348 ²⁾	047810 ²⁾	049228 ²⁾
	6,0	G 3/8	EPDM	PVC	049337 ²⁾	049678 ²⁾	049291 ²⁾	-
	8,0	G 3/8	FKM	PVC	049697 ^{2) 3)}	052800 ²⁾	052302 ²⁾	-
	8,0	G 3/8	EPDM	PVC	048698 ^{2) 3)}	050967 ²⁾	050701 ²⁾	450543 ²⁾
	4,0	G 1/4	FKM	VA	055244 ²⁾	056934 ²⁾	052441 ²⁾	-
	4,0	G 1/4	EPDM	VA	136290 ²⁾	-	136292 ²⁾	-
	6,0	G 1/4	FKM	VA	040482 ²⁾	057086 ²⁾	054595 ²⁾	-
	6,0	G 1/4	EPDM	VA	049113 ²⁾	-	-	-
	4,0	G 3/8	EPDM	PP	049017 ²⁾	-	-	-
	6,0	G 3/8	EPDM	PP	052161 ²⁾	-	-	-
	4,0	G 3/8	FFKM ²⁾	PVDF	133109 ²⁾	-	079653 ²⁾	-
	4,0	G 3/8	FFKM ²⁾	PTFE	122632 ^{2) 3)}	-	077191 ²⁾	457453 ^{2) 4)}
	4,0	G 3/8	FFKM	PTFE	151733 ²⁾	-	136205 ²⁾	-
4,0	G 3/8	FFKM	PTFE	132098 ^{2) 3)}	-	-	-	
B ¹⁾	4,0	G 3/8	FKM	PVC	-	-	050158 ²⁾	-
	6,0	G 3/8	EPDM	PVC	135416 ^{2) 3)}	-	-	-
	4,0	G 3/8	FFKM	PTFE	132096 ^{2) 3)}	-	-	-
C	6,0	G 3/8	FFKM	PTFE	132097 ^{2) 3)}	-	-	-
	4,0	G 3/8	FKM	PVC	051701 ²⁾	-	-	-
	6,0	G 3/8	EPDM	PVC	-	-	051577 ²⁾	-
	4,0	G 3/8	FFKM	PTFE	-	-	130625 ²⁾	-
	4,0	G 3/8	FKM	PTFE	044771 ²⁾	-	-	-
	6,0	G 3/8	FFKM ²⁾	PTFE	131364 ^{2) 3)}	-	-	-
E	4,0	G 1/4	EPDM	VA	-	-	135858 ²⁾	-
	4,0	G 1/4	FKM	VA	-	-	042457 ²⁾	-
	6,0	G 3/8	EPDM	PVC	048673 ²⁾	-	-	-
	4,0	G 3/8	FFKM ²⁾	PVDF	-	-	120402 ²⁾	-
	4,0	G 3/8	FFKM ²⁾	PTFE	151715 ²⁾	-	130934 ²⁾	-
F	4,0	G 3/8	FFKM ²⁾	PTFE	135028 ²⁾	-	-	-
	6,0	G 3/8	FKM	PVC	049533 ²⁾	052181 ²⁾	047916 ²⁾	-
	6,0	G 3/8	EPDM	PVC	040062 ²⁾	048760 ²⁾	050491 ²⁾	-
	4,0	G 3/8	FFKM ²⁾	PTFE	-	-	124239 ²⁾	-
	6,0	G 3/8	FFKM ²⁾	PTFE	141134 ²⁾	-	-	-
6,0	G 3/8	FKM	PTFE	051256 ²⁾	-	-	-	

¹⁾ The listed Item-no. and circuit functions have a housing with straight pass

²⁾ Seal material seat seal is FFKM; Seal material seat O-ring FKM

³⁾ The listed Item-no. are equipped with a high-performance coil (60 W-inrush, 3 W-operation) and injected cable

⁴⁾ Cable plug is not part of the delivery.

Order chart for accessories

Description	Item no.
Mounting plate cpl. for DIN rail mounting	013253 ¹⁾

¹⁾ Use only with 2/2 way globe valves



Circuit functions

A 2/2 way direct-acting solenoid valve, normally closed

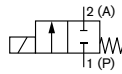

B 2/2 way direct-acting solenoid valve, normally open

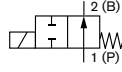

C 3/2 way direct-acting solenoid valve, normally closed

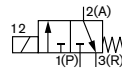

D 3/2 way direct-acting solenoid valve, normally open

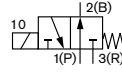

E 3/2 way mixing solenoid valve

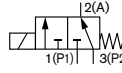

F 3/2 way direct-acting, distribution solenoid valve

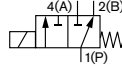

T 3/3 way direct-acting solenoid valve, flow direction optional

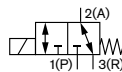

Explosion proofed version

Technical data	
Orifice	DN2.0 to 8.0
Available housing materials	PTFE PVC (resistant acc. to DIN 8062, 8061) PP (Polypropylen) PVDF Stainless steel 1.4401
Seal materials	FKM / FFKM / EPDM
Medium	
for FKM	Oxydizing acids and substances, hot oils with additives, salt solutions, waste gases, technical vacuum
FFKM	Aggressive acids, hot air, hot oil, aromatics, ether, esther, ketones (please note Bürkert chemical resistance chart).
for EPDM	Alkalis, acids up to medium concentration, alkaline washing- and bleaching lyes
All Materials	For more detailed information please consult the resistance chart
Medium temperature for body material PVDF or PP	EPDM: -20 to +70 °C FKM: -10 to +70 °C FFKM: -10 to +70 °C
Medium temperature for body material PTFE or VA	EPDM: -20 to +90 °C FKM: -10 to +90 °C FFKM: -10 to +90 °C
Medium temperature for body material PVC	EPDM: -20 to +50 °C FKM: -10 to +50 °C FFKM: -10 to +50 °C
Ambient temperature.	max. +50 °C
Viscosity	max. 37 mm ² /s
Voltagess	24 V; 230 V (further voltages on request)
Frequency	AC/DC
Voltage tolerance	+/- 10%
Duty cycle	100%
Electrical connection	Impressed cable (HO5RN-F3G,3x0,75 mm ²) Terminal box without safety fuse
Protection class	IP65
Thermal insulation class of the coil	H
Type of protection	II 2 G Ex mb IIC T4 Gb II 2 D EX mb IIIC T130° Db
Certificate	EPS 16 ATEX 1 111 X IECEX EPS 16.0049X
Safety fuse	Appropriate inrush current (see ordering chart)
Installation	As required, preferably with actuator upright
Weight [kg]	
Material VA	1,15
Material PVDF, PP und PVC	0,62
Material PTFE	0,75

Cycling rate

	Max. cycling rate	For medium temperature	For ambient temperature
Version 1	20/min	Up to +70 °C	Up to +40 °C
Version 2	5/min	Up to +90 °C	Up to +40 °C

Power consumption

Inrush [W]	Operation [W]
40	3

Response times

Orifice [mm]	Opening [ms]	Closing [ms]
2 - 8	30	40

Response times [ms]:

Measurement at the valve output 6 bar and +20 °C

Opening: Pressure rise 0 to 90%,

Closing: Pressure drop 100 to 10%

Technical data (continued)

Pressure range and flow rate

Circuit function	DN	Water KV-value ¹⁾ [m ³ /h]	Pressure range ²⁾ [bar]
A / F	2	0,1	0 – 6
	4	0,3 ³⁾	0 – 4
	6	0,6 ⁴⁾	0 – 2
	8	1,0	0 – 1
C / D	2	0,1	0 – 3
	4	0,3 ³⁾	0 – 2
	6	0,6 ⁴⁾	0 – 1
	8	1,0	0 – 0,3
B	2	0,1	0 – 6
	4	0,3 ³⁾	0 – 4
	6	0,6 ⁴⁾	0 – 2
	8	1,0	0 – 1
E	2	0,1	0 – 3
	4	0,3 ³⁾	0 – 2
	6	0,6 ⁴⁾	0 – 1
	8	1,0	0 – 0,2

¹⁾ Measured at +20 °C, 1 bar pressure at valve inlet and free outlet.

²⁾ Pressure data [bar]: Measured as overpressure to the atmospheric pressure

³⁾ Nominal size 4 mm and seal material FKM bzw. FFKM KV-value reduces to 0,24 m³/h

⁴⁾ Nominal size 6 mm and seal material FKM bzw. FFKM KV-value reduces to 0,48 m³/h

Additional options

Option	Variable code	Specifications
Oxygen versions	NL02	Suitable for application with oxygen (non-metallic materials in contact with medium are BAM-proofed)
Higher purity requirements e.g. oil-, grease- and silicon free	NL05	Parts in contact with the medium are specially cleaned and the valves appropriate packed
Vacuum version	NA02	Suitable for vacuum up to -0,98 bar
Improved purity and tightness requirements	NA03	Parts in contact with the medium are specially cleaned and the leak test to 10-4 mbar x l / sek

Recommended backup value

(at coil with certificate EPS 16 ATEX 1 111 X/ IECEx EPS 16.0049X no fuse is required)

Voltage [V]	Max. current [A]
24	2
230	0.5
110-120	0.8

Dimensions [mm]

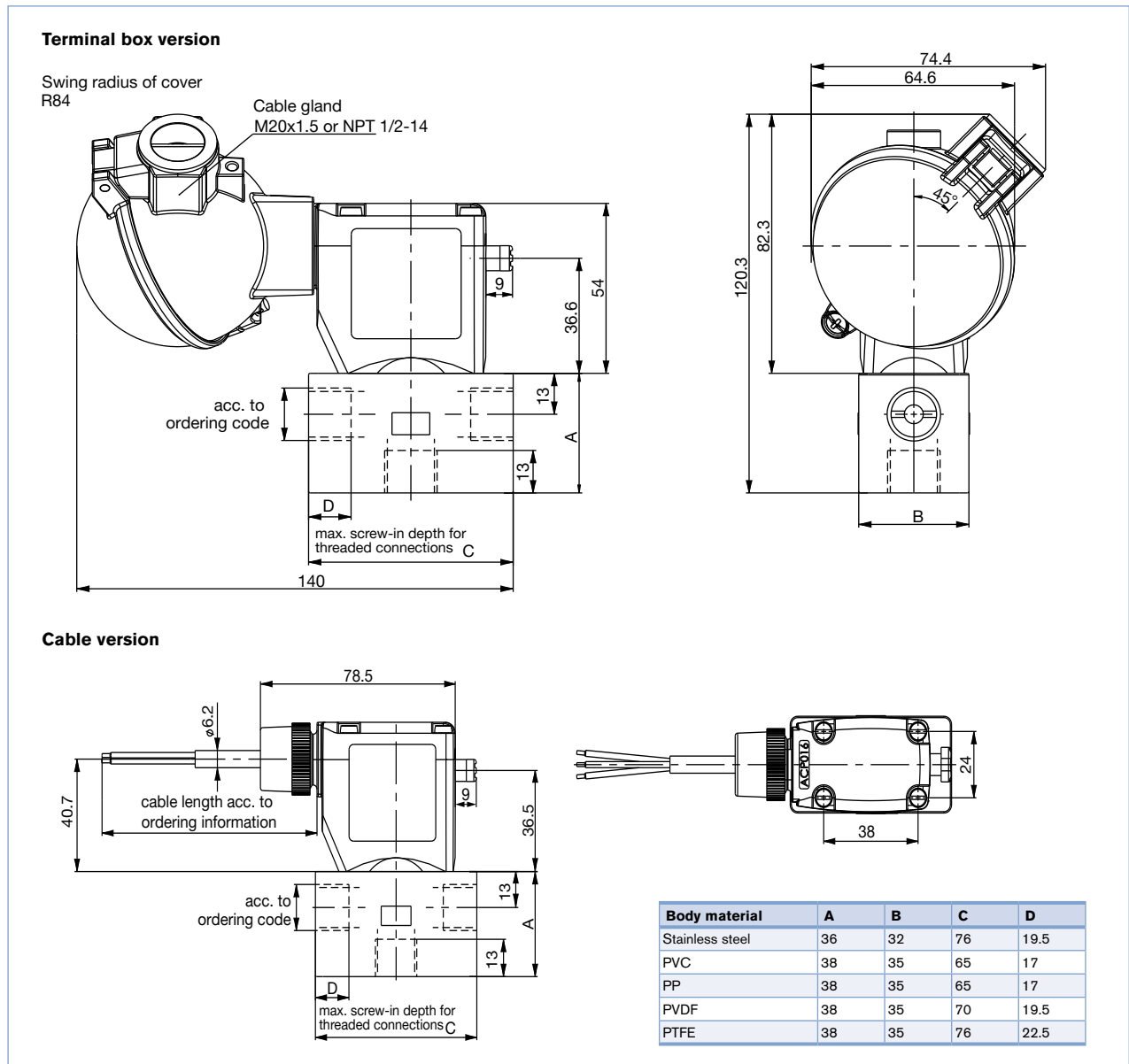

Note - Attaching device: M4 x 5 holes on the bottom of the housing on the hole pattern 38 x 24mm





PIN Assignments

The connections marked with 1, 2 and 3 are labelled in the drawing according to the circuit function table on the left.

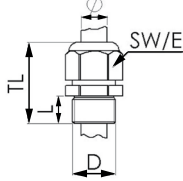

Circuit function	Connection 1	Connection 2	Connection 3
A	A	P	
B	P	B	
C	P	R	A
D	R	P	B
E	P1	P2	A
F	A	B	P

Ex-Cable glands

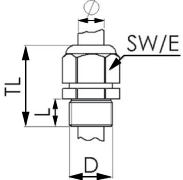
(polyamide version included in delivery / surcharge applied for brass nickel plated version)

Photo	Description	Ex Approvals		Item no	Drawing										
		Certification	Identifica-tion												
	Brass, nickelplated, 6-13 mm	PTB 04 ATEX 1112 X, IECEx PTB 13.0027X	II 2 G Ex e IIC Gb, II 2 D Ex tb IIIC Db IP68,	773278 	 <table border="1"> <tr><td>TL</td><td>29-37 mm</td></tr> <tr><td>L</td><td>6 mm</td></tr> <tr><td>D</td><td>20</td></tr> <tr><td>SW</td><td>24 mm</td></tr> <tr><td>E</td><td>27 mm</td></tr> </table>	TL	29-37 mm	L	6 mm	D	20	SW	24 mm	E	27 mm
TL	29-37 mm														
L	6 mm														
D	20														
SW	24 mm														
E	27 mm														
	Polyamide, 7-13 mm	PTB 13 ATEX 1015 X, IECEx PTB 13.0034X	II 2 G Ex e IIC Gb, II 2 D Ex tb IIIC Db IP68	773277 	 <table border="1"> <tr><td>TL</td><td>36-45 mm</td></tr> <tr><td>L</td><td>10 mm</td></tr> <tr><td>D</td><td>20</td></tr> <tr><td>SW</td><td>24 mm</td></tr> <tr><td>E</td><td>28 mm</td></tr> </table>	TL	36-45 mm	L	10 mm	D	20	SW	24 mm	E	28 mm
TL	36-45 mm														
L	10 mm														
D	20														
SW	24 mm														
E	28 mm														

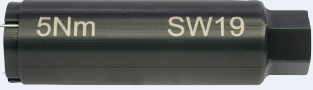
Special tool to turn the junction box (not included in delivery)

Photo	Description	Item no.
	Set SC02-AC10 Special wrench Service Manual	293488 

DTS 1000010904 EN Version: N Status: RL (released | freigegeben | validé) printed: 10.02.2020

To find your nearest Bürkert facility, click on the orange box →

www.burkert.com

In case of special application conditions, please consult for advice.

Subject to alterations
© Christian Bürkert GmbH & Co. KG

1712/10_EU-en_00891601