

Digital batch controller



- Compact or remote version for DN06 to DN400, PN10
- Dosing
- Automatic calibration: TEACH-IN
- Possible check of input/output signals
- Batched volume and totalizers displayed

Type 8025B can be combined with...



Type S020
INSERTION fitting



Type 8070
Positive displacement
flow sensor



Type 8030
INLINE flow sensor



Type 2712 (8630)
Continuous
TopControl system

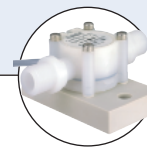

Type 8031
Flow sensor

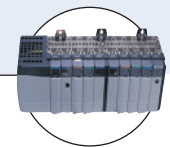

PLC

The batch controller is specially designed for use in neutral and slightly aggressive, solid-free liquids.

The device is available in different models:

- Compact batch controller with integrated paddle-wheel sensor.
- Remote batch controller for panel or wall mounting for connection to Bürkert 8020 / 8030 / 8031 / 8041 / 8071 sensors or to a flow sensor from the market; sensors with open collector output, relay reed output or coil can be operated by this batch controller.

Technical data (common to the various versions)

General data

Display	15x60 mm, 8-digit LCD, alphanumeric, 15 segments, 9 mm high
Electrical connections	shielded cable with 1.5 mm ² max. cross-section

Environment

Ambient temperature	0°C up to +60°C (32°F to 140°F) (operation and storage)
Relative humidity	≤ 80 %, without condensation

Standards and approvals

Standard	EN 61000-6-2, EN 61000-6-3
EMC	EN 61010-1
Security	Complying with article 3 of §3 from 2006/95/CE directive.*
Pressure	EN 60068-2-6
Vibration	EN 60068-2-27
Shock	

* For the 2006/95/CE pressure directive, the device can only be used under following conditions (depend on max. pressure, pipe diameter and fluid).

Type of fluid	Conditions
Fluid group 1, §1.3.a	DN 25 only
Fluid group 2, §1.3.a	DN ≤ 32, or DN > 32 and PN*DN ≤ 1000
Fluid group 1, §1.3.b	PN*DN ≤ 2000
Fluid group 2, §1.3.b	DN ≤ 200

System version

The compact version



combines a paddle-wheel flow sensor and an electronic module with a display in an IP65 enclosure.

The output signals are provided via two cable glands. Bürkert designed fitting ensures simple installation of the Bürkert sensor into pipes from DN15 to DN400.

The panel-mounted version



consists of an electronic module 8025 integrated in a front-cover. The associated separate flow sensor should have a pulse output signal, like Bürkert sensor Type 8020, 8030... (see interconnection chart) or another flow sensor available from the market.

The output signals are provided on a terminal strip.

The wall-mounted version



consists of an electronic module 8025 in an IP65 enclosure. The associated separate flow sensor should have a pulse output signal, like Bürkert sensor Type 8020, 8030... (see interconnection chart) or another flow sensor available from the market.

The output signals are provided on a terminal strip via cable glands.

Operation and display

The device can be calibrated by means of the K-factor, or via the TEACH-IN function. User adjustments, such as measuring range, engineering units, pulse output are carried out on site.

The operation is specified according to three levels:

▶ **Indication in operating mode / Display**

- dosing amount
- dosing mode
- main totalizer
- daily totalizer with reset function

▶ **Parameter definition**

- language
- engineering units
- K-factor / TEACH-IN function
- selection of dosing mode
- over-run correction
- alarm
- function mode of relays
- reset main totalizer

▶ **Test**

- display of state of binary inputs
- relay test
- frequency test

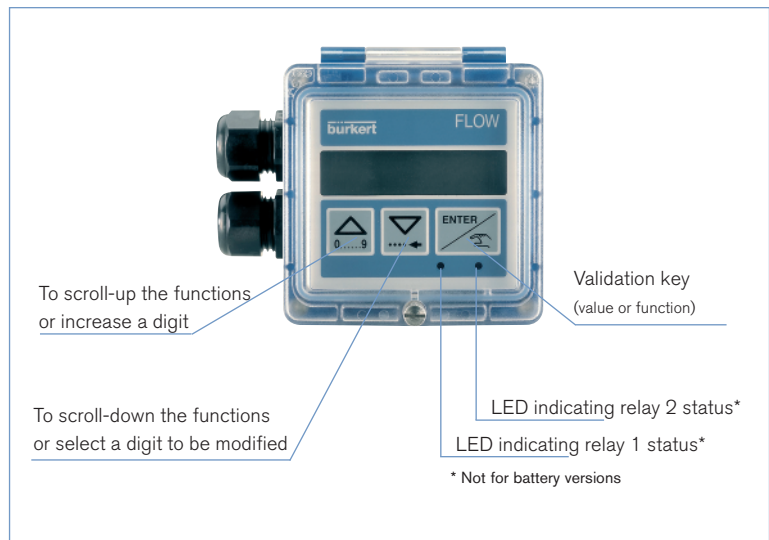

Compact batch controller



Design

When liquid flows through the pipe, the paddle-wheel with 4 inserted magnets is set in rotation, producing a measuring signal in the sensor (Hall sensor). The frequency modulated induced voltage is proportional to the flow velocity of the fluid. A conversion coefficient (K-factor, available in the instruction manual of the S020 fitting), specific to each pipe (size and material) enables the conversion of this frequency into volume. The electronic component converts the measured signal and displays the actual value of volume.



The 8025 batch controller is mounted in a pipe in series with the valve; the unit controls the opening of the valve and measures the quantity of the fluid which flows. The unit also closes the valve when the pre-programmed quantity has been delivered.

The electronic component needs a voltage supply of 12-30 V DC or 115/230 V AC, and two output relays are used to activate the valves and to initiate alarms. The following dosing and filling operations are possible:

- **Local dosing:**
the user enters the quantity to be metered and initiates the dosage from the keypad.
- **Local dosing with pre-set quantity:**
the user selects a quantity which has been pre-set and initiates the dosage from the keypad.
- **Remote control dosing**
using a rotary knob (selecting a pre-set quantity) or binary data inputs.
- **Dosing controlled by a PLC unit**
using binary data inputs.
- **Automatic dosing controlled by variation of pulse duration.**
The quantity of the dose is directly proportional to the duration of a pulse.

General data	
Compatibility	with fittings S020 (see corresp. data sheet)
Materials	Housing, cover, lid, nut: PC Front panel foil: Polyester Screws: Stainless steel Cable glands: PA Wetted parts materials: Fitting: Brass, stainless steel 1.4435/316L, PVC, PP or PVDF Sensor finger, paddle-wheel: PVDF Axis and bearing / Seal: Ceramics / FKM (EPDM option)
Electrical connections	Cable glands M20x1.5
Complete device data	
Pipe diameter	DN15 to DN400
Measuring range	0.3 to 10 m/s (Hall transducer version)
Fluid temperature with fitting in	PVC: 0°C up to 50°C (32°F to 122°F) PP: 0°C up to 80°C (32°F to 176°F) PVDF, brass or stainless steel: -15°C up to 80°C (32°F to 176°F)
Fluid pressure max.	PN10 (145.1 PSI) (see pressure/temperature diagram)
Viscosity / Pollution	300 cSt. max. / 1% max.
Accuracy	Teach-In: ±0.5% of F.S.* (at 10 m/s) ¹⁾ Standard K-factor: ±(0.5% of F.S.* + 2.5% of Reading) ¹⁾
Linearity	±0.5% of F.S.* (at 10 m/s) ¹⁾
Repeatability	≤ 0.4% of Reading ¹⁾
Electrical data	
Power supply	12-30 V DC, filtered and regulated
Current consumption with sensor	≤ 70 mA - without consumption of inputs/outputs
Input	4 binary inputs, 5... 30 V DC; impedance 3.3 kΩ Functions: dosing quantity choice, start-stop dosing
Output	Batch status: Polarized, potential free, 5...30 V DC; 100 mA, protected, line drop at 100 mA: 1.5 VDC - for status and alarm message Relay: 2 relays, freely programmable, 3 A, 230 V AC
Technical specifications 115/230 V AC	
Voltage supply available inside the device	27 V DC regulated, max. current: 125 mA integrated protection: fuse 125 mA temporised power: 3 VA
Standard	
Protection class	IP65 with cable gland mounted and tightened or with obturator locked if not used.

¹⁾ Under reference conditions i.e. measuring fluid=water, ambient and water temperature=20°C (68°F), applying the minimum inlet and outlet pipe straights, matched inside pipe dimensions.

* F.S.=Full scale (10 m/s)

Accuracy diagram

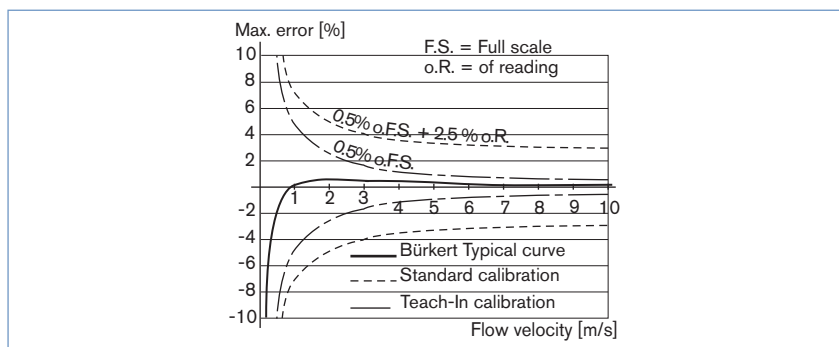

Installation

The 8025 batch controller can easily be installed into any Bürkert INSERTION fitting system (S020) by just fixing the main nut. Minimum straight upstream and downstream distances must be observed. According to the pipe's design, necessary distances can be bigger or use a flow conditioner to obtain the best accuracy. For more information, please refer to EN ISO 5167-1.

EN ISO 5167-1 prescribes the straight inlet and outlet distances that must be complied with when installing fittings in pipe lines in order to achieve calm flow conditions. The most important layouts that could lead to turbulence in the flow are shown below, together with the associated prescribed minimum inlet and outlet distances. These ensure calm, problem-free measurement conditions at the measurement point.

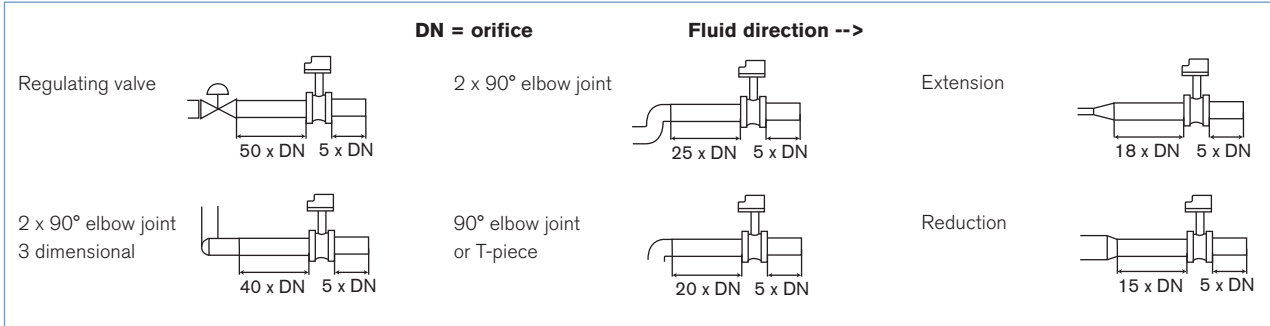

The batch controller can be installed into either horizontal or vertical pipes.

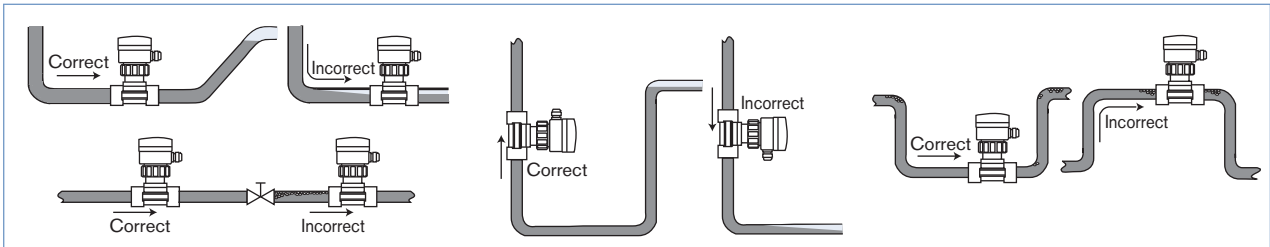

Pressure and temperature ratings must be respected according to the selected fitting material.
The suitable pipe size is selected using the diagram Flow/Velocity/DN.
The batch controller is not designed for gas flow measurement

Pressure/Temperature diagram

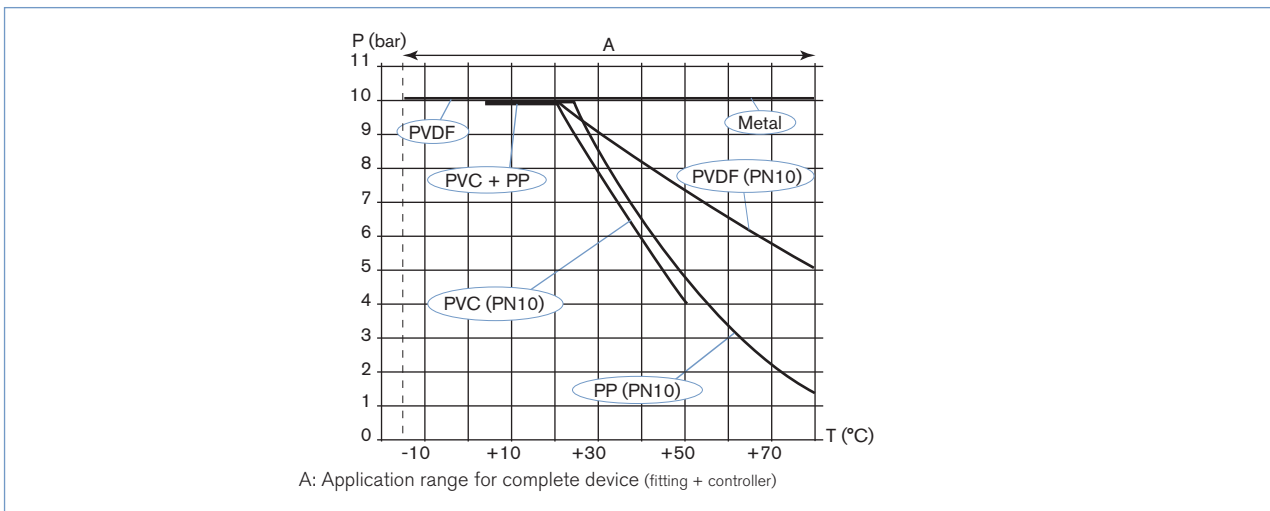

Diagram Flow/Velocity/DN

Example:

- Specification of nominal flow: 10 m³/h
- Ideal flow velocity: 2...3 m/s

For these specifications, the diagram indicates a pipe size of DN40 [or DN50 for (*) mentioned fittings]

Flow rate

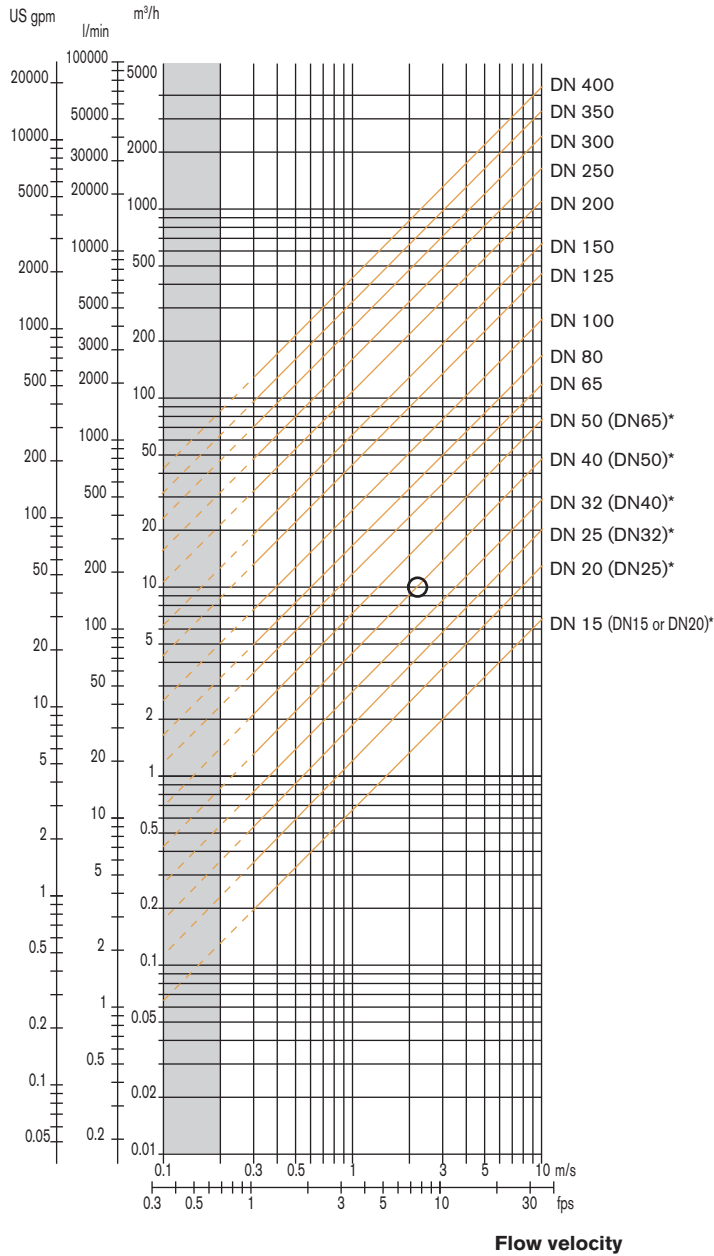

- * for following fittings with:
- external threads acc. to SMS 1145
 - weld ends acc. to SMS 3008, BS 4825 / ASME BPE or DIN 11850 Series 2
 - Clamp acc. to SMS 3017/ ISO 2852, BS 4825 / ASME BPE or DIN 32676

Dimensions [mm]

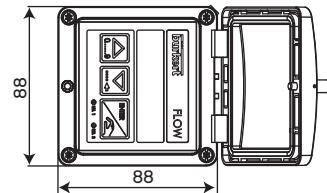
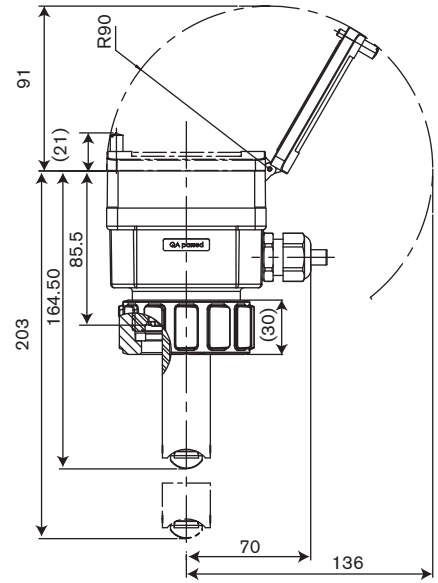

Note:

The length of the sensor finger depends on the fitting used.

See data sheet Type S020.

More info.

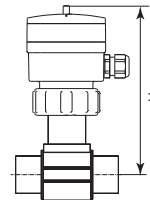

DN	H			
	T-Fitting	Saddle	Plastic spigot	Metal spigot
15	187			
20	185			
25	185			
32	188			
40	192			
50	198	223		193
65	198	221	206	199
80		226	212	204
100		231	219	214
110		227		
125		234	254	225
150		244	261	236
180		268		
200		280	282	257
250			300	317
300			312	336
350			325	348
400			340	

Remote batch controller (for connection to Bürkert sensor or other sensor types...)

The remote batch controller

is available in two versions:

- Panel-mounted



- Wall-mounted



Technical specifications 115/230 V AC

Voltage supply available inside the device	27 V DC regulated, max. current: 125 mA integrated protection: fuse 125 mA temporised power: 3 VA
--	---

General data	
Compatibility	Bürkert flow sensor with frequency output 8020, 8030, 8030HT, 8041, 8031, 8070, 8071 or other sensors with compatible electrical data.
Materials Housing, cover Front panel foil Screws Cable glands	PC (panel-mounted version); ABS (wall-mounted version) Polyester Stainless steel PA
Electrical connections	Terminals (panel-mounted version) or terminals via cable glands M16x1.5 (wall-mounted version)
Electrical data	
Power supply Panel-mounted version Wall-mounted version	12-30 V DC (V+), filtered and regulated 12-30 V DC, filtered and regulated or 115/230 V AC 50/60 Hz (see technical specifications 115/230 V AC)
Current consumption with sensor	≤ 70 mA - without consumption of inputs/outputs
Sensor input Frequency range	2.5 Hz up to 700 Hz Open collector NPN, Coil, TTL, CMOS
Sensor output Voltage supply Current consumption	12...30 V DC (V+) or 0...18 V DC (V+ - 12 V DC) (with a 12-30 V DC powered controller); +15 V DC or + 27 V DC (with a 115/230 V AC powered controller) max. current available from controller: 25 mA (115/230 V AC version) 100 mA (12-30 V DC version)
Input	4 binary inputs, 5... 30 V DC; Functions: dosing quantity choice, start-stop dosing
Output Batch status Relay	Polarized, potential free, 5...30 V DC; 100 mA, protected, line drop at 100 mA: 1.5 V DC - for status and alarm message 2 relays, freely programmable, 3 A, 230 V AC
Standards	
Protection class	IP65 (panel-mounted and wall-mounted version) IP20 (panel-mounted version, inside the cabinet).

Dimensions [mm]

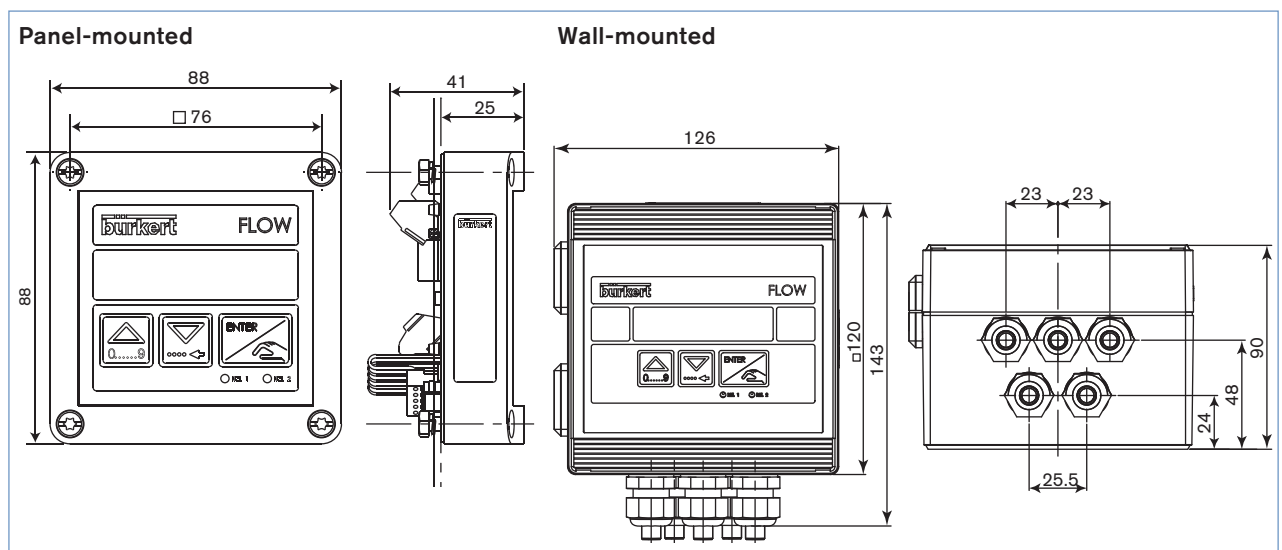

Ordering chart for compact batch controller Type 8025

Compact batch controller with integrated paddle-wheel sensor

A compact batch controller Type 8025 consists of:

- an INSERTION batch controller 8025
- an INSERTION fitting Type S020 (DN15 - DN400) (Refer to corresponding data sheet - has to be ordered separately)

Specifications	Voltage supply	Relays	Sensor version	Electrical connection	Item no.
2 totalizers	12-30 V DC	2	Hall, short	2 cable glands	419 520
			Hall, long	2 cable glands	419 522
	115/230 V AC	2	Hall, short	2 cable glands	419 521
			Hall, long	2 cable glands	419 529

Note: FKM gasket in standard; 1 Kit including a black EPDM gasket for the sensor, an obturator for an M20 x 1.5 cable gland, a 2 x 6 mm multiway seal and a mounting instruction sheet is supplied with each batch controller.

Ordering chart for remote batch controller Type 8025

Remote 8025 batch controller (panel- or wall-mounted) for connection to Bürkert or other sensors.

A complete remote batch controller Type 8025 consists of:

- a remote batch controller Type 8025 (wall-mounted or panel-mounted)
- a Bürkert flow sensor* or any (has to be ordered separately)

Specifications	Voltage supply	Relays	Sensor version	Electrical connection	Item no.
Panel mounted, 2 totalizers	12-30 V DC	2	see note	Terminal	419 536
Wall-mounted, 2 totalizers	12-30 V DC	2	see note	5 cable glands	433 740
	115/230 V AC	2	see note	5 cable glands	433 741

* NOTE: See the chart about compatible and recommended interconnection possibilities with Bürkert sensors.

Ordering chart - accessories for batch controller Type 8025 (has to be ordered separately)





Specifications	Item no.
Set with 2 cable glands M20x1.5 + 2 neoprene flat seals for cable gland or plug + 2 screw-plugs M20x1.5 + 2 multiway seals 2x6 mm	449 755
Set with 2 reductions M20x1.5 /NPT1/2" + 2 neoprene flat seals for cable gland or plug + 2 screw-plugs M20x1.5	551 782
Set with 1 stopper for unused cable gland M20x1.5 +1 multiway seal 2x6 mm for cable gland + 1 black EPDM gasket for the sensor + 1 mounting instruction sheet	551 775
Ring	619 205
Union nut	619 204
Set with 1 green FKM and 1 black EPDM gasket	552 111

Interconnection possibilities with other Bürkert flow sensors

Sensor Type	Remote batch controller	
	Panel-mounted	Wall-mounted
8020 Hall version (short or long) - Frequency output with pulse signal (NPN, PNP, Open Collector)	X	X
8020 Hall "Low Power" version (short or long) - Frequency output with pulse signal (NPN, Open Collector)	X	X
8030/8070 Hall version - Frequency output with pulse signal (NPN, PNP, Open Collector)	X	X
8030/8070 Hall "Low Power" version - Frequency output with pulse signal (NPN, Open Collector)	X	X
8030 High temperature - Frequency output with pulse signal (NPN, PNP, Open Collector)	X	X
SE30 Ex	X	X
8031 - Frequency output with pulse signal (NPN)	X	X
8041 - Frequency output with pulse signal (NPN)	X	X ¹⁾
8071 - Frequency output with pulse signal (NPN)	X	X

X = Compatible or recommended interconnection possibilities

¹⁾ except sensor with Item no. 419543

Available S020 Fitting DN	DN 15	DN65
	T-fitting S020 	Short sensor
Welding tab S020 	DN50	DN200 DN350 Short sensor Long sensor
Fusion spigot S020 	DN65	DN100 DN400 Short sensor Long sensor
Screw-on S020 	DN100	DN400 Long sensor
Saddle S020 	DN50	DN200 Long sensor

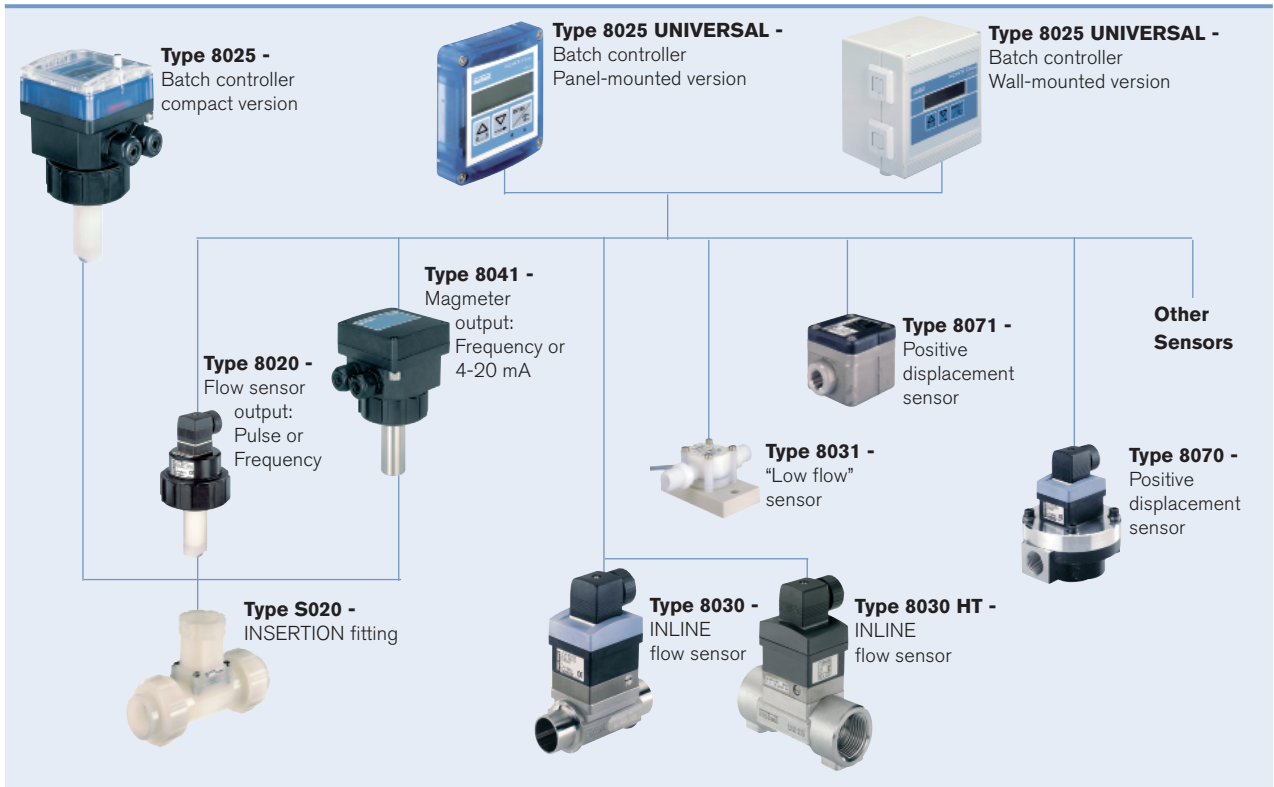

To find your nearest Bürkert facility, click on the orange box →

www.burkert.com

In case of special application conditions, please consult for advice.

Subject to alteration.
© Christian Bürkert GmbH & Co. KG

1107/9_EU-en_00891775